

E

E-Series

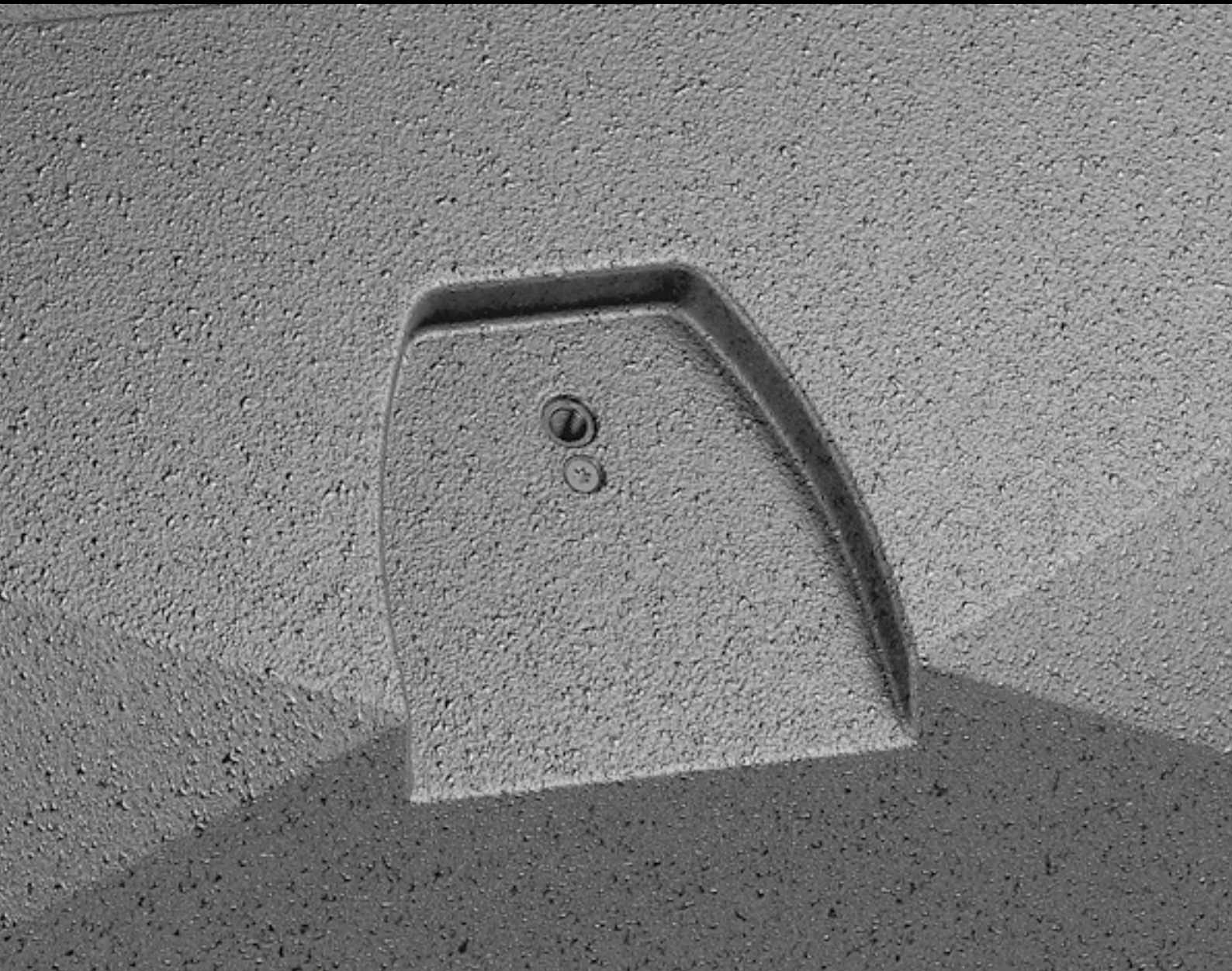

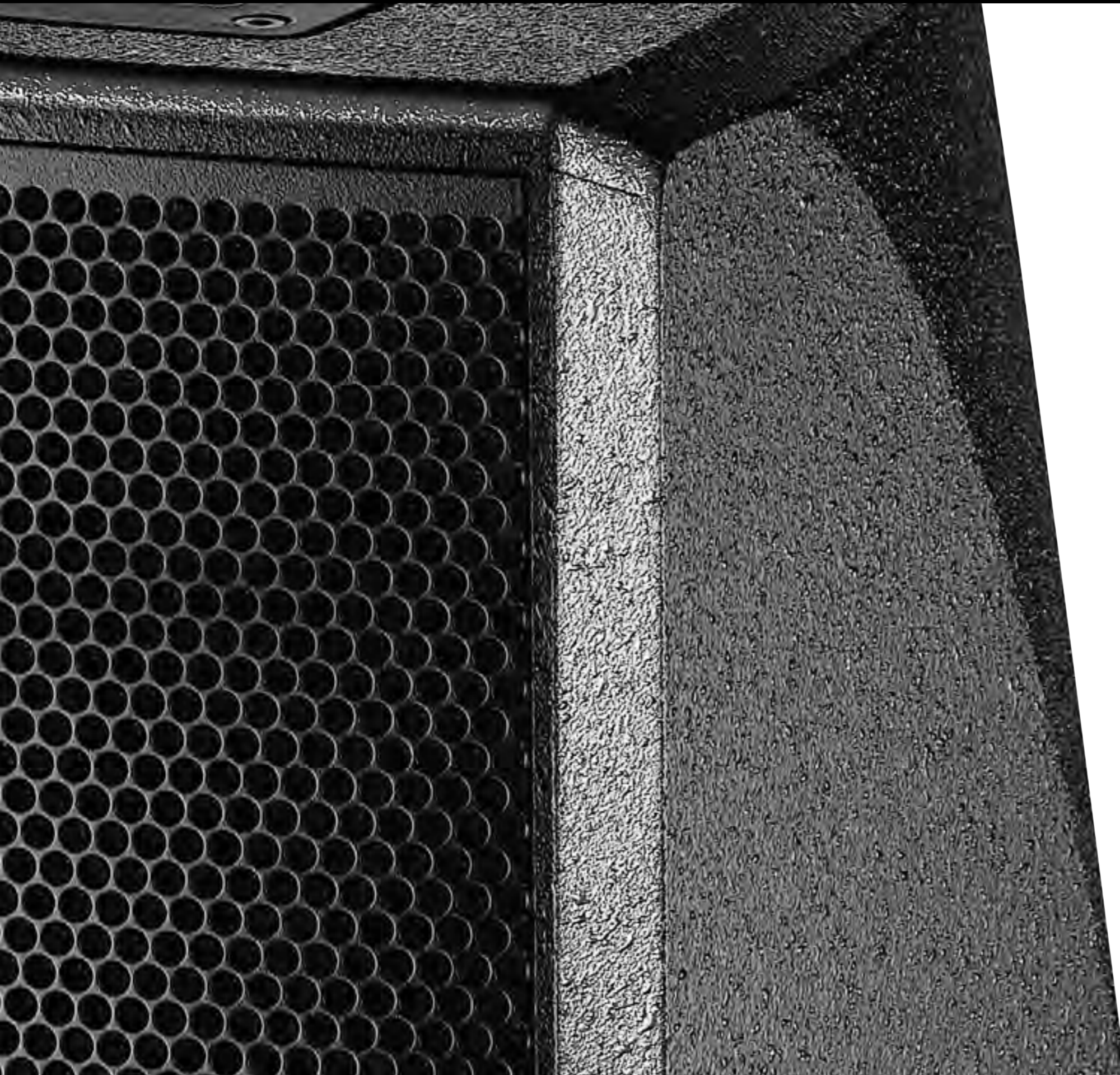

The d&b System reality	4
The E-Series	6
The E4 loudspeaker	10
The E5 loudspeaker	11
The E6 loudspeaker	12
The E8 loudspeaker	13
The E12 loudspeaker and E12-D loudspeaker	14
The E12X and E15X subwoofer	15
The B8 subwoofer	16
The B4 subwoofer	17
The E4/E5 and B8 mounting accessories	18
The E4/E5 and B8 mounting examples	19
The E6 mounting accessories and examples	20
The E8/E12 mounting accessories and examples	22
The E-Series Weather Resistant, Special Colour and Custom solutions options	24
The E4 and E5 cases	25
The d&b ArrayCalc simulation software	26
The d&b NoizCalc immission modelling software	26
The d&b Remote network	27
The d&b amplifiers	28
The controller setups and operation with d&b amplifiers	30
The E-Series frequency responses	32
The d&b amplifier output modes	33
The DS10 and DS20 Audio network bridges	34
The DS100 Signal Engine	34
The E-Series configuration examples	35
The E-Series cables and adapters	36
The E-Series product overview	38

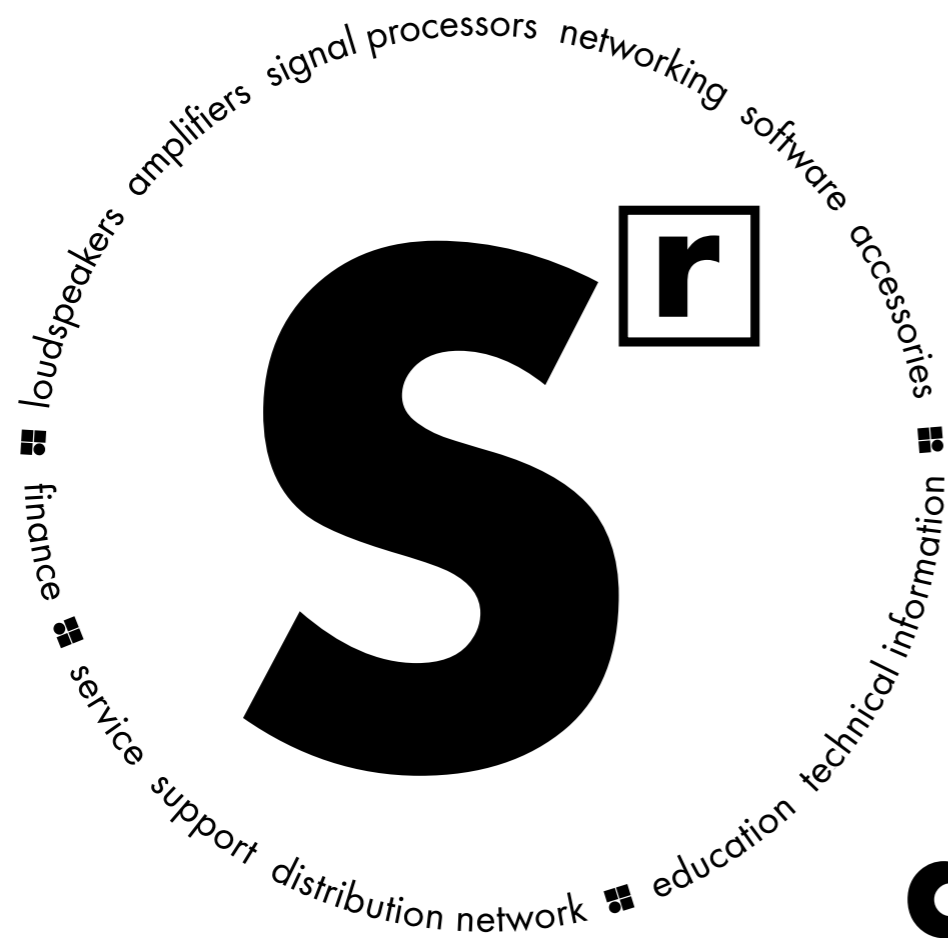

d&b System reality

As the name implies a d&b audiotechnik system is not just a loudspeaker. Nor is it merely a sum of the components: loudspeakers, amplifiers, signal processors, networking, software and accessories. Right from the outset the d&b audiotechnik approach was to build integrated sound reinforcement systems

that actually are more than the combination of parts: an entirety where each fits all. Every element is tightly specified, precisely aligned and carefully matched to achieve maximum efficiency. For ease of use, all the user-definable parameters are incorporated, allowing the possibility of adjustment, either

directly, via remote control surfaces, or integrated within wider networks. Neutral sound characteristics leave the user all the freedom needed to realize whatever the brief. At the same time d&b offers finance, service and support, a knowledgeable distribution network, education and training as well as technical

information, so the same optimal acoustic result is achieved consistently by every system anywhere, at any time. In reality: the d&b System reality.

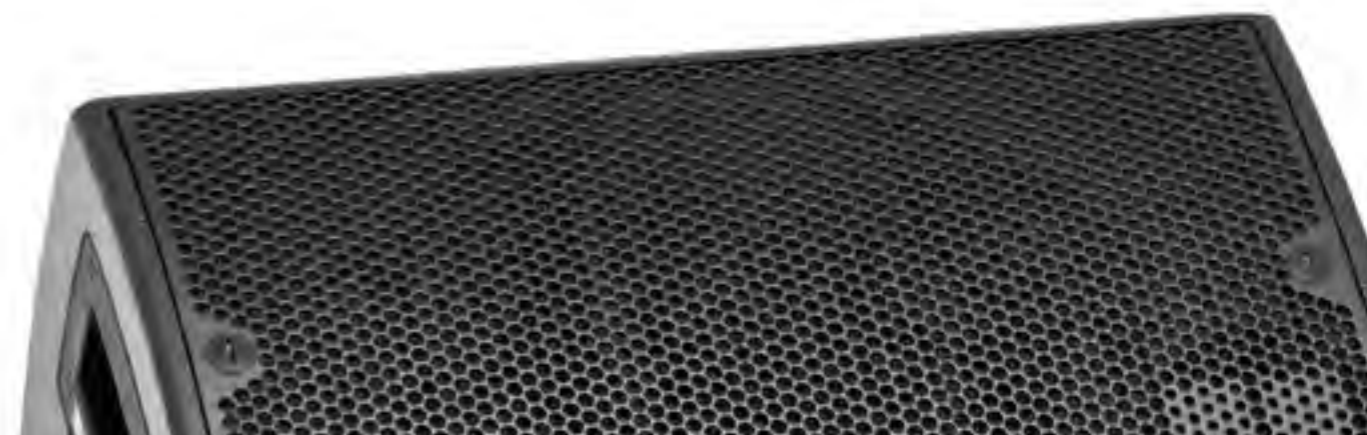

The complete **E-Series** is a range of five small to medium sized point source loudspeakers of a multifaceted moulded construction to achieve the maximum deployment versatility. They utilize direct radiating low frequency elements with coaxially mounted high frequency sections. Three direct radiating subwoofers compliment

the E-Series loudspeakers. The compact and unobtrusive design makes these loudspeakers visually discreet, yet a combination of accurate directivity control, extended bass response and appropriate sound pressure levels, make them audibly impressive for such small loudspeakers. A distinctive aspect of the coaxial

design is the accurate directivity control it provides, particularly in the critical midrange that is so vital for voice reproduction. The design incorporates all the necessary fittings into small, lightweight enclosures, making the loudspeakers quick and easy to handle. The E-Series is predominantly used in theatres,

conferences, industrial presentations, broadcast studios and as surround sound, delay and fill systems. They are intended for both mobile and installation applications, can be colour matched to interior designs and can be weather protected for climatically hostile environments.

The E-Series

The **E4** and **E5** are the littlest loudspeakers in the E-Series which are specifically suited for near field applications featuring 4" or 5" LF drivers respectively and a coaxially mounted HF dome tweeter. They produce a wide symmetrical directivity up to very high frequencies.



The **E6**, larger **E8** and even larger **E12** and **E12-D** are high performance multipurpose loudspeakers utilizing a patented coaxial horn assembly that can be rotated without the need for any special tools permitting changes to the dispersion angle enabling deployment of these loudspeakers either vertically or horizontally. The E6 and E8 employ a 6.5" and 8" coaxial driver respectively with an HF compression driver mounted on the unique rotatable horn assembly. Compared to the E4 and E5, the slightly larger E6 has a greater SPL to size ratio yet still provides a very compact reinforcement solution that inspires through its sound quality and is also perfectly compatible with the larger E8 and E12. The E8's sound pressure level capabilities when coupled with a subwoofer can realize ambitious application possibilities. The E12 shares the same physical, acoustical and mechanical design elements as the smaller E8. The larger cabinet volume and a 12" LF driver provide a warm and full low frequency extension and higher power capabilities. All other aspects of the loudspeaker are quite simply scaled, allowing exactly the same broad range of application possibilities. The E12-D is a wider dispersion version of the E12 loudspeaker.

The **E12X-SUB** and **E15X-SUB** are lightweight, low profile, bass-reflex subwoofers utilizing 12" and 15" long excursion drivers respectively. They can be operated in two modes, an active mode with a dedicated amplifier configuration, or passively using the internal crossover connected in parallel with either an E8 loudspeaker for the E12X-SUB or an E12 loudspeaker for the E15X-SUB driven from a single amplifier channel.

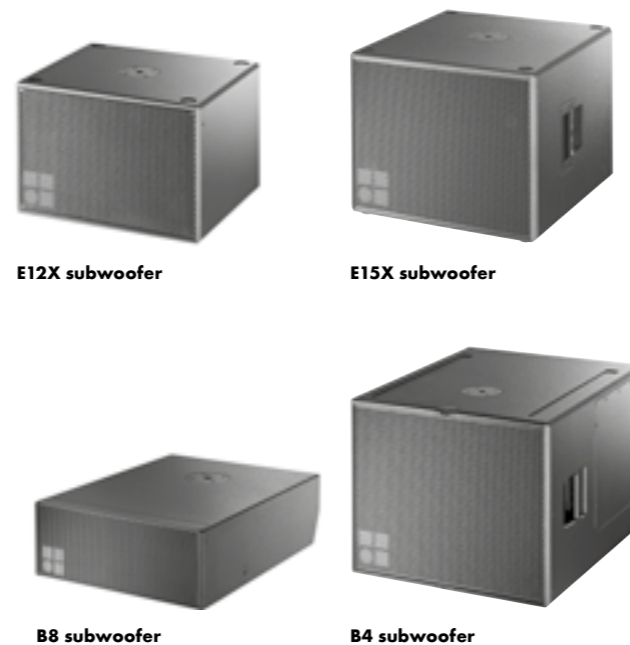

The **B4-SUB** is a compact high performance cardioid subwoofer utilizing two long excursion neodymium drivers in an integrated cardioid setup to avoid unwanted energy behind the system. This passive cardioid design can be operated from a single amplifier channel. The **B8-SUB** is an ultra-low profile compact subwoofer measuring just 170mm in height. An actively driven omnidirectional subwoofer, the cabinet houses two 6.5" LF drivers with ferrite magnets in a bass-reflex design, capable of reproducing frequencies from 43 Hz to 170 Hz.

The d&b software offering aides the entire system setup process. The d&b **ArrayCalc** simulation software allows the virtual optimization of loudspeaker line arrays, point source and column loudspeakers as well as subwoofers and their adjustment to venue conditions. The d&b **NoizCalc** immission modelling software uses international standards to model noise immission from one or more d&b loudspeaker systems. NoizCalc takes data from ArrayCalc and calculates the sound propagation towards the far field. The complete system configuration simulated in ArrayCalc is assimilated by the d&b R1 Remote control software into an intuitive graphical user interface to manage the amplifiers, and loudspeakers, from anywhere in the venue. The **R90** Touchscreen remote control provides quick, reliable, and effortless operation of day-to-day functions of a preconfigured d&b system, without needing expert level knowledge of audio.

The planning process using BIM is supported with Revit files available for all loudspeakers and accessories, creating accurate project data and visualisation.

d&b amplifiers are specifically designed for use with d&b loudspeakers, and are at the heart of the d&b system approach. These devices contain extensive Digital Signal Processing capabilities to provide comprehensive loudspeaker management and specific switchable filter functions to precisely target the system response for a wide variety of applications. The four channel **D20** and **D40** amplifiers are intended for mobile applications requiring medium to high Sound Pressure Levels. The **5D**, **10D**, **30D** and **40D** amplifiers provide four channels and are intended for integration within permanent installations. The 5D and 10D are designed to drive smaller d&b loudspeakers and applications requiring lower Sound Pressure Levels whereas the high powered 30D and 40D are intended to drive all d&b loudspeakers at medium to high SPLs. These amplifiers all provide extensive user-definable equalization and delay capabilities to fine tune the system for artistic taste.

The d&b Audio network bridges interface between audio transport networks and AES3 digital audio signals while also providing distribution of Ethernet control data. The **DS10** supports Dante networks, while the **DS20** is used for the open standards-based Milan protocol.

The **DS100** Signal Engine is based on a specialized rack mount 3 RU audio processor with Audinate Dante networking. It provides a 64 x 64 audio matrix with level and delay adjustments at all cross points. Additional software modules provide dynamic source positioning and emulated acoustics functions.

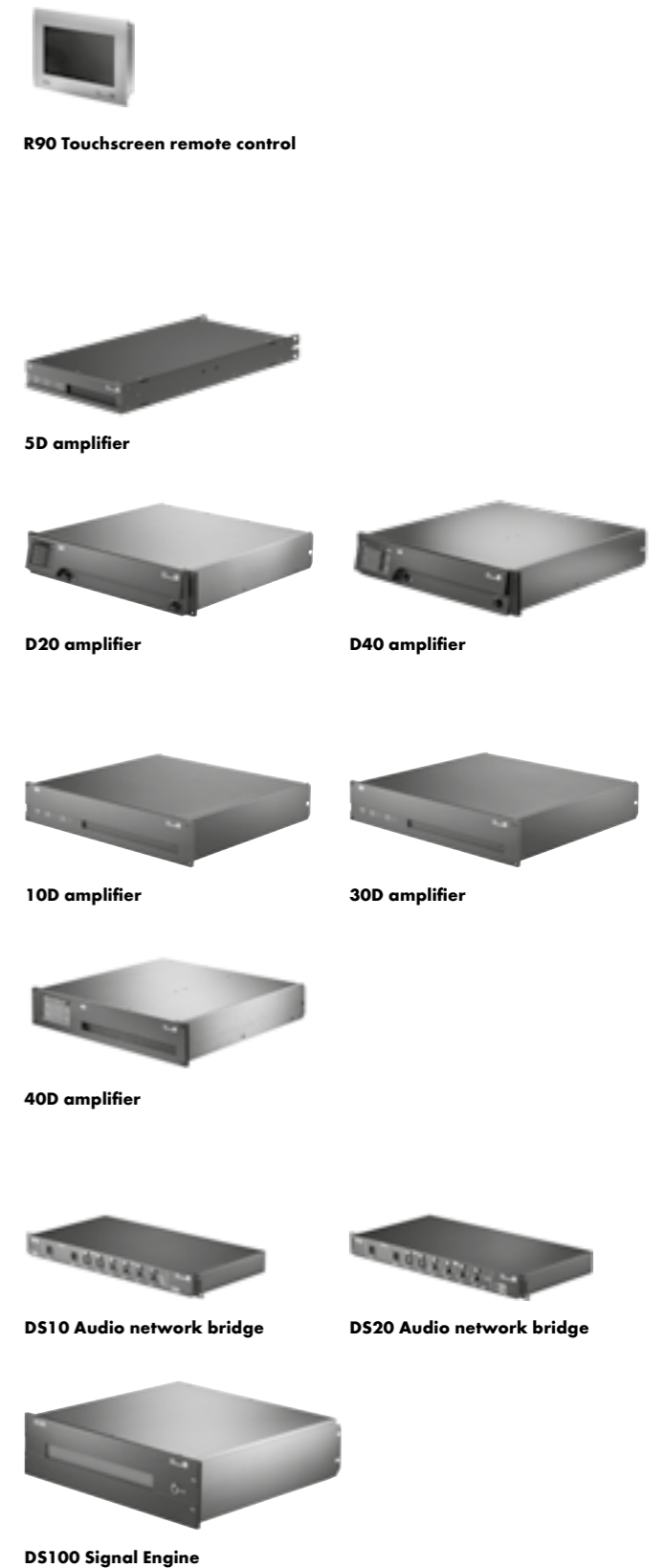

The E4 loudspeaker

E4 loudspeaker

The E4 is a lightweight 2-way passive loudspeaker using a neodymium LF driver and a coaxially mounted wide dispersion dome tweeter. The E4's coaxial design employs a 4" driver in a highly compact sealed enclosure and offers a wide symmetrical dispersion pattern in the horizontal and vertical plane while the cabinet may be mounted in either attitude.

It can be used stand-alone or supplemented by different subwoofers from the E-Series.

The enclosure is injection moulded with an impact resistant paint finish. The front of the loudspeaker cabinet is protected by a rigid metal grill and incorporated into the rear panel is an M10 threaded insert to accept the ball joint adapter.

System data

Frequency response (-5 dB standard) 130 Hz - 20 kHz
 Frequency response (-5 dB CUT mode)..... 180 Hz - 20 kHz
 Max. sound pressure (1 m, free field)¹
 with 10D 114 dB
 with D20/D40/D80 115 dB
 with 5D/30D/D40..... 115 dB

Loudspeaker data

Nominal impedance 16 ohms
 Power handling capacity (RMS/peak 10 msec)60/400 W
 Nominal dispersion angle 100° conical
 Components4" driver with neodymium magnet
0.75" dome tweeter coaxially mounted
passive crossover network
 Connections 2 x NL4
 1 x two pole push terminal
 Weight..... 1.1 kg (2.4 lb)

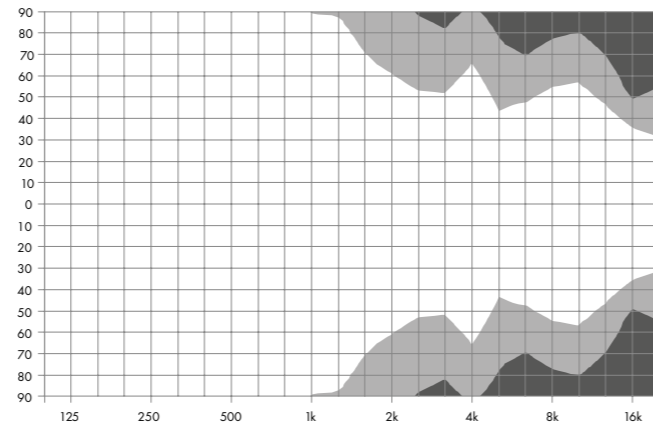

E4 horizontal dispersion characteristics²

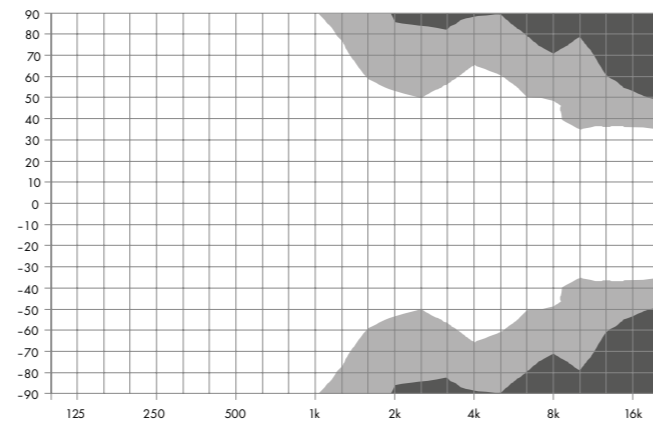

E4 vertical dispersion characteristics²

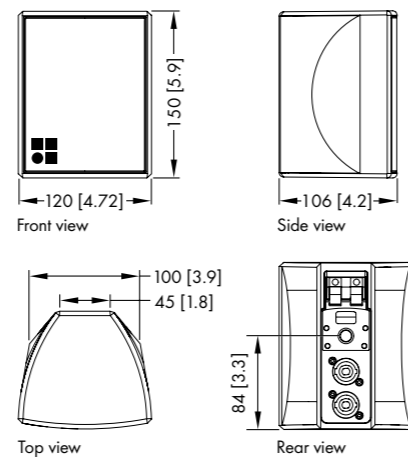

E4 cabinet dimensions in mm [inch]

¹ Broadband measurement, pink noise, crest factor 4, peak measurement, linear weighting
² Dispersion angle vs frequency plotted using lines of equal sound pressure (isobars) at -6 dB and -12 dB

The E5 loudspeaker

E5 loudspeaker

The E5 is a lightweight 2-way passive loudspeaker using a ferrite LF driver and a coaxially mounted wide dispersion dome tweeter. The E5's coaxial design employs a 5" driver in a compact bass-reflex enclosure and offers a wide symmetrical dispersion pattern in the horizontal and vertical plane while the cabinet may be mounted in either attitude.

It can be used stand-alone or supplemented by different subwoofers from the E-Series.

The enclosure is injection moulded with an impact resistant paint finish. The front of the loudspeaker cabinet is protected by a rigid metal grill and incorporated into the rear panel is an M10 threaded insert to accept the ball joint adapter.

System data

Frequency response (-5 dB standard) 85 Hz - 20 kHz
 Frequency response (-5 dB CUT mode)..... 130 Hz - 20 kHz
 Max. sound pressure (1 m, free field)¹
 with 10D 116 dB
 with D20/D40/D80 117 dB
 with 5D/30D/D40..... 117 dB

Loudspeaker data

Nominal impedance 16 ohms
 Power handling capacity (RMS/peak 10 msec)60/400 W
 Nominal dispersion angle 100° conical
 Components 5" driver with ferrite magnet
1" dome tweeter coaxially mounted
passive crossover network
 Connections 2 x NL4
 1 x two pole push terminal
 Weight..... 2.7 kg (6.0 lb)

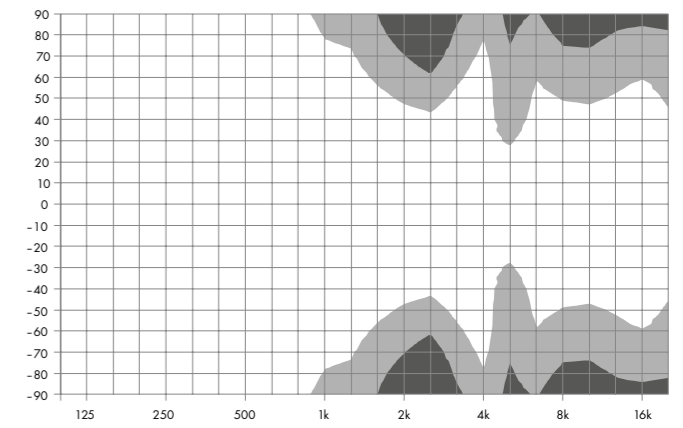

E5 horizontal dispersion characteristics²

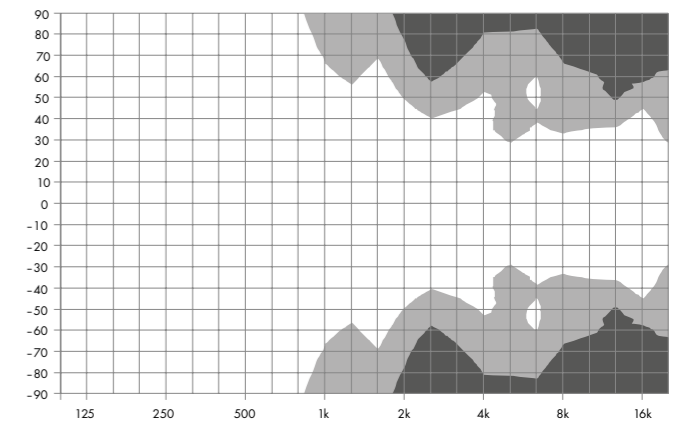

E5 vertical dispersion characteristics²

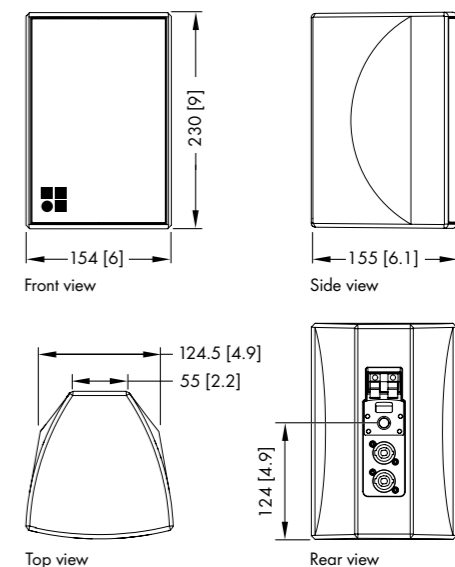

E5 cabinet dimensions in mm [inch]

¹ Broadband measurement, pink noise, crest factor 4, peak measurement, linear weighting
² Dispersion angle vs frequency plotted using lines of equal sound pressure (isobars) at -6 dB and -12 dB

The E6 loudspeaker

E6 loudspeaker

The E6 is a high performance 2-way multipurpose loudspeaker employing an integrated coaxial driver with a neodymium magnet assembly. The 1" exit HF compression driver and constant directivity horn are accommodated within the circumference of the 6.5" LF driver. The horn with its 100° x 55° dispersion pattern (h x v) can easily be rotated through 90° without the use of tools to provide a 55° x 100° dispersion pattern. The E6 can be used for speech and music applications as a stand-alone full range system, or incorporated into larger distributed sound reinforcement situations. It can be mounted on loudspeaker stands or flown from overhead bars, while the multifaceted shape of the enclosure allows use either in a vertical or horizontal orientation as well as deployment as a stage monitor. With the addition of an E12X-SUB or any other E-Series subwoofer, the E6 can also reproduce high level music program. The E6 cabinet has an impact resistant paint finish. The front is protected by a magnetically attached rigid metal grill backed by an acoustically transparent fabric. The grill can easily be removed without tools to modify the horn orientation. The cabinet incorporates a handle.

System data

Frequency response (-5 dB standard).....85 Hz - 20 kHz
 Frequency response (-5 dB CUT mode) 120 Hz - 20 kHz
 Max. sound pressure (1 m, free field)¹
 with 10D..... 120 dB
 with D20/D40/D80 123 dB
 with 5D/30D/40D..... 123 dB

Loudspeaker data

Nominal impedance20 ohms
 Power handling capacity (RMS/peak 10 msec)..... 150/800 W
 Nominal dispersion angle (h x v) 100° x 55°
 rotatable through 55° x 100°
 Components 6.5" driver with neodymium magnet
1" exit compression driver with 1.75" coil and rotatable CD horn
passive crossover network
 Connections 2 x NLT4 F/M
 optional 2 x NL4
 Weight5 kg (11 lb)

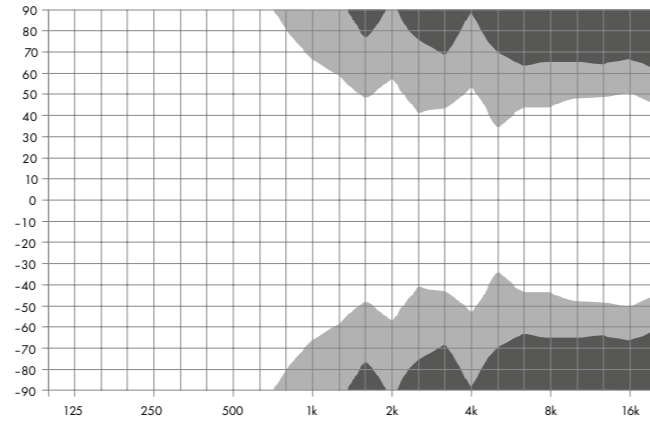

E6 horizontal dispersion characteristics²

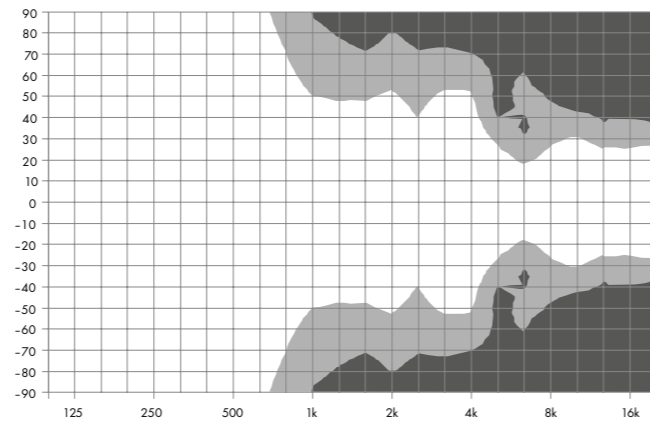

E6 vertical dispersion characteristics²

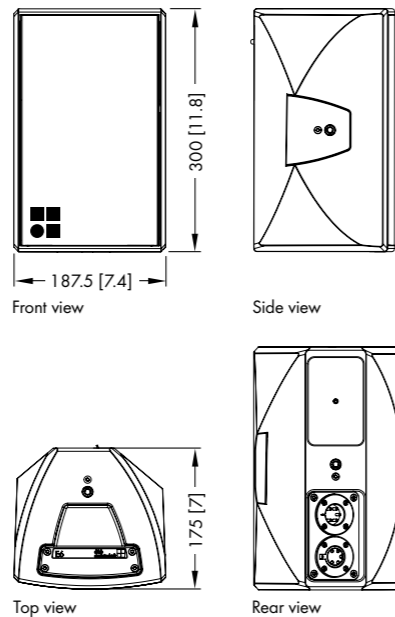

E6 cabinet dimensions in mm [inch]

¹ Broadband measurement, pink noise, crest factor 4, peak measurement, linear weighting
² Dispersion angle vs frequency plotted using lines of equal sound pressure (isobars) at -6 dB and -12 dB

The E8 loudspeaker

E8 loudspeaker

The E8 is a high performance 2-way multipurpose loudspeaker employing an integrated coaxial driver with a neodymium magnet assembly. The 1" exit HF compression driver and constant directivity horn are accommodated within the circumference of the 8" LF driver. With its 90° x 50° dispersion pattern (h x v), the horn is easily rotatable through 90° without the use of tools to provide a 50° x 90° dispersion pattern. The E8 can be used for speech and music applications as a stand-alone full range system, or incorporated into larger distributed sound reinforcement situations. It can be mounted on loudspeaker stands or flown from overhead bars, while the multifaceted shape of the enclosure allows use either in a vertical or horizontal orientation as well as deployment as a stage monitor. With the addition of an E12X-SUB or any other E-Series subwoofer, the E8 can also reproduce high level music program. The E8 cabinet is constructed from polyurethane integral hard foam with an impact resistant paint finish. The front of the loudspeaker cabinet is protected by a rigid metal grill backed by an acoustically transparent foam. The grill can easily be removed without tools to modify the horn orientation. The cabinet incorporates a handle and a socket to accept loudspeaker stands.

System data

Frequency response (-5 dB standard).....62 Hz - 18 kHz
 Frequency response (-5 dB CUT mode) 120 Hz - 18 kHz
 Max. sound pressure (1 m, free field)¹
 with 10D..... 126 dB
 with D20/D40/D80 129 dB
 with 5D/30D/40D..... 129 dB

Loudspeaker data

Nominal impedance16 ohms
 Power handling capacity (RMS/peak 10 msec)..... 150/800 W
 Nominal dispersion angle (h x v)90° x 50°
 rotatable through 50° x 90°
 Components8" driver with neodymium magnet
1" exit compression driver with 1.75" coil and rotatable CD horn
passive crossover network
 Connections 2 x NLT4 F/M
 optional 2 x NL4
 Weight7.3 kg (16.1 lb)

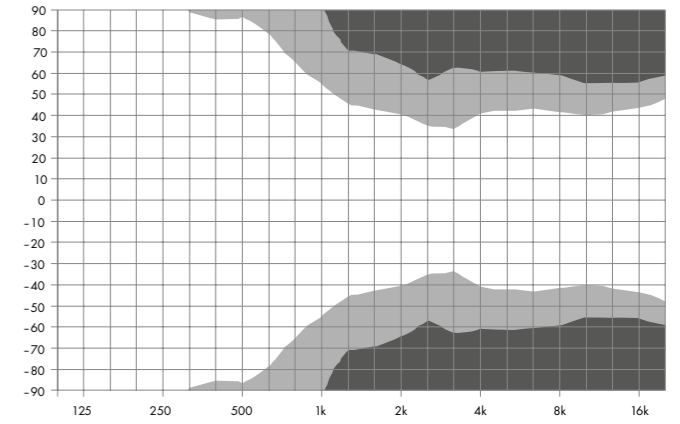

E8 horizontal dispersion characteristics²

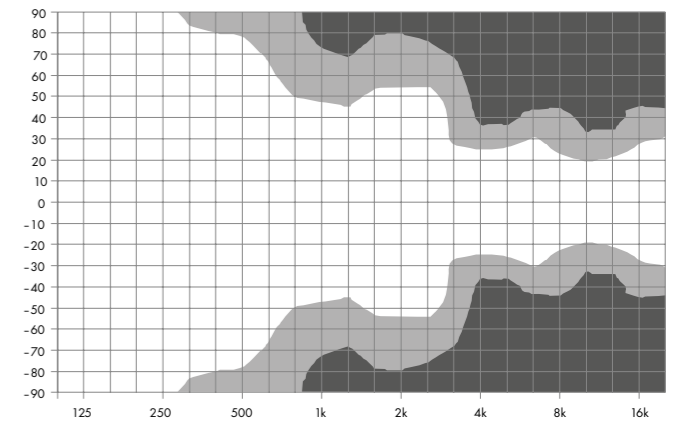

E8 vertical dispersion characteristics²

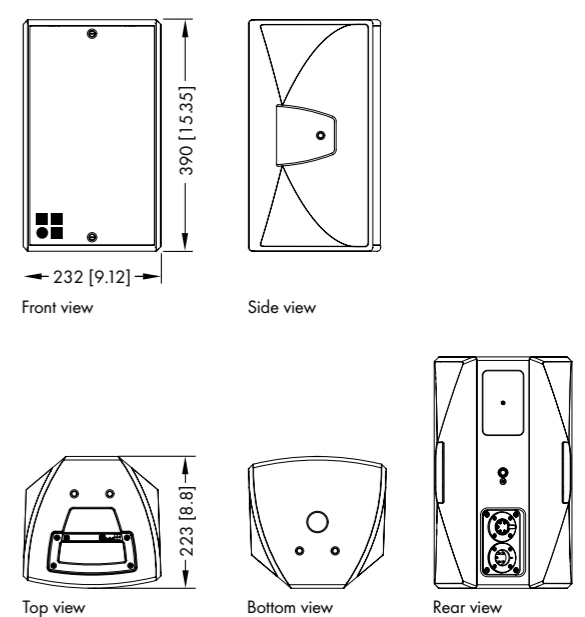

E8 cabinet dimensions in mm [inch]

¹ Broadband measurement, pink noise, crest factor 4, peak measurement, linear weighting
² Dispersion angle vs frequency plotted using lines of equal sound pressure (isobars) at -6 dB and -12 dB

The E12 loudspeaker

The E12-D loudspeaker

E12/E12-D loudspeaker

The E12 and E12-D are high performance 2-way multipurpose loudspeakers employing an integrated coaxial driver with a neodymium magnet assembly. The 1.3" exit HF compression driver and constant directivity horn are accommodated within the circumference of the 12" LF driver. The E12 has an 80° x 50° dispersion pattern (h x v), while the E12-D has a wider 110° x 50° pattern. The horns in both loudspeakers are easily rotatable through 90° without the use of tools, providing 50° x 80° or 50° x 110° dispersion patterns. The E12 and E12-D can be used for speech and music applications as a stand-alone full range system, or incorporated into larger distributed sound reinforcement situations. They can be mounted on loudspeaker stands or flown from overhead bars, while the multifaceted shape of the enclosure allows use either in a vertical or horizontal orientation as well as deployment as a stage monitor. With the addition of an E15X or B4 subwoofer, the E12 and E12-D loudspeakers can also easily reproduce high level music program.

The E12 and E12-D cabinets are constructed from polyurethane integral hard foam with an impact resistant paint finish. The front of each loudspeaker cabinet is protected by a rigid metal grill backed by an acoustically transparent foam. The grill can easily be removed without tools to modify the horn orientation. Both cabinets incorporate a pair of handles and a hidden socket to accept loudspeaker stands.

System data E12 • E12-D

Frequency response (-5 dB standard) 50 Hz - 18 kHz
 Frequency response (-5 dB CUT mode)..... 100 Hz - 18 kHz
 Max. sound pressure (1 m, free field)¹
 with 10D 131 • 130 dB
 with D20/30D/40D 134 • 133 dB
 with D40/D80..... 134 • 133 dB

Loudspeaker data E12 • E12-D

Nominal impedance 8 ohms
 Power handling capacity (RMS/peak 10 msec) 300/1600 W
 Nominal dispersion angle (h x v) 80° • 110° x 50°
 rotatable through 50° x 80° • 110°
 Components 12" driver with neodymium magnet
 ... 1.3" exit compression driver with 3" coil and rotatable CD horn
 passive crossover network
 Connections 2 x NLT4 F/M
 optional 2 x NL4
 Weight..... 16 kg (35 lb)

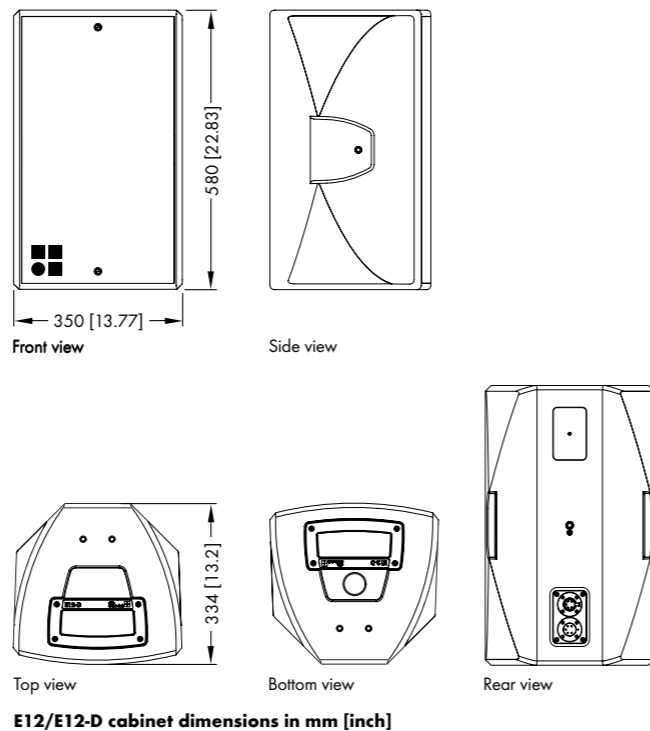
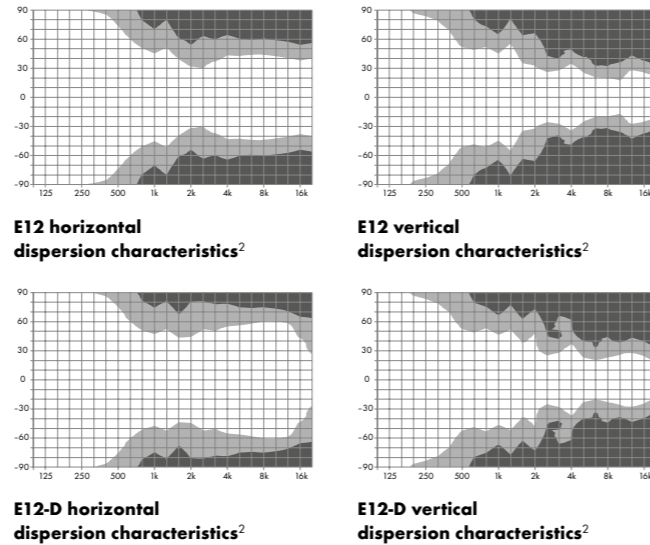

¹ Broadband measurement, pink noise, crest factor 4, peak measurement, linear weighting
² Dispersion angle vs frequency plotted using lines of equal sound pressure (isobars) at -6 dB and -12 dB

The E12X subwoofer

The E15X subwoofer

E12X/E15X subwoofer

The E12X-SUB and E15X-SUB are compact, light weight, high performance subwoofers for use with d&b E-Series loudspeakers. They employ a long excursion 12" respectively 15" neodymium driver in a bass-reflex enclosure. The built in passive crossover network allows the subwoofer to be connected in parallel to the E8 loudspeaker (E12X-SUB) or to the E12 or E12-D loudspeaker (E15X-SUB) on the same amplifier channel, greatly extending the low frequency headroom and bandwidth of the systems. As an alternative it can be operated actively, driven by its own amplifier channel without the need for any changes to the cabinet. In active mode the E12X-SUB or E15X-SUB can be used to supplement any of the E-Series cabinets. The cabinets of the subwoofers are constructed from marine plywood and have an impact resistant paint finish, a handle and an M20 threaded flange on the top to accept the d&b Loudspeaker stand winder M20. The front of the loudspeaker cabinets are protected by a rigid metal grill backed by an acoustically transparent foam. Four rubber feet prevent cabinet movement and protect the bottom panel against scratching. Correspondingly shaped recesses are incorporated in the top panel of each cabinet to accept these and to prevent cabinet movement when stacked.

System data E12X • E15X

Frequency response (-5 dB standard) ... 45 - 100 • 37 - 140 Hz
 Frequency response (-5 dB 140 Hz mode).....
 45 - 100 • 37 - 100 Hz
 Max. sound pressure (1 m, free field)¹
 with 10D 124 dB • 127 dB
 with 5D (only E12X)..... 127dB
 with D20/D40/D80 127 dB • 130 dB
 with 30D/40D..... 127 dB • 130 dB

Loudspeaker data E12X • E15X

Nominal impedance 8 ohms
 Power handling capacity (RMS/peak 10 msec) 300/1600 W
 Components 12" • 15" driver
 passive crossover network
 Connections 2 x NLT4 F/M
 optional 2 x NL4
 Weight..... 18 kg (40 lb) • 24 kg (53 lb)

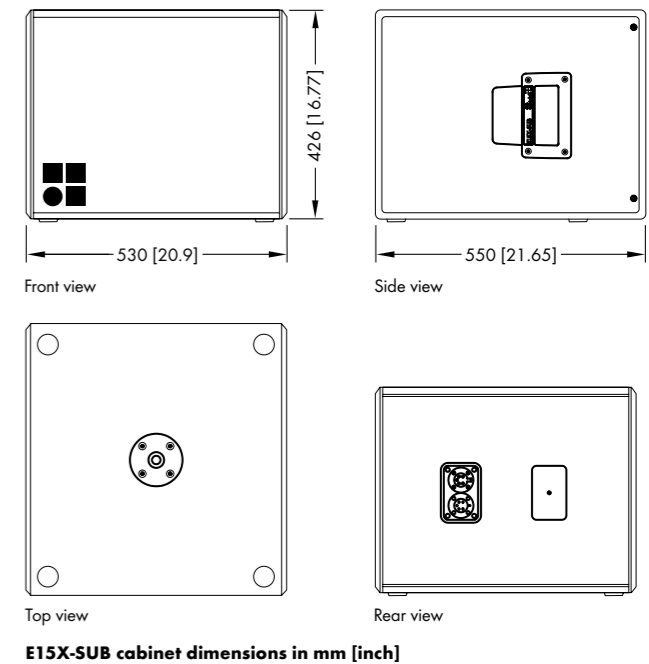
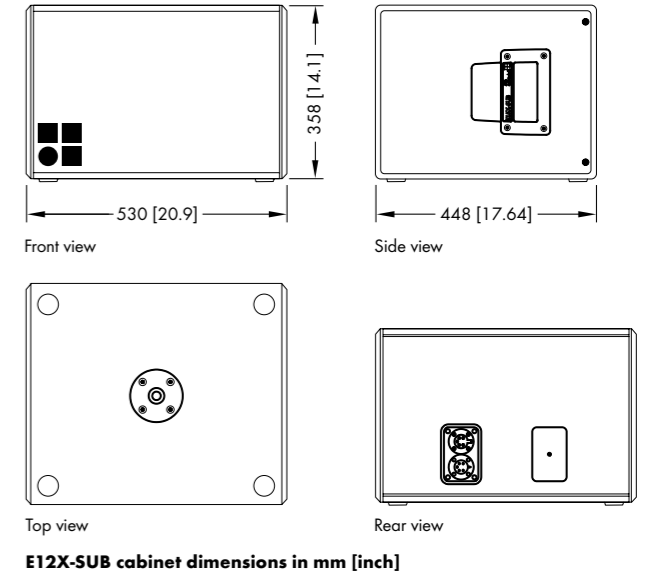

¹ Broadband measurement, pink noise, crest factor 4, peak measurement, linear weighting

The B8 subwoofer

B8 subwoofer

The B8 is an ultra-low profile compact subwoofer. At 170mm in height, the B8 readily fits under stages and stairs. An actively driven omnidirectional subwoofer, the cabinet houses two 6.5" LF drivers with ferrite magnets in a bass-reflex design, capable of reproducing frequencies from 43 Hz to 170 Hz. The B8-SUB can be paired with all current d&b amplifiers, achieving a max SPL of 122 dB (30D/D20/D80). For setup purposes, the B8 can be used in landscape or portrait mode, installed under stages, stairs or in ceilings, or flown with small mid-high d&b loudspeakers. The enclosure is constructed from marine plywood with an impact resistant black paint finish. The front of the cabinet is protected by a rigid metal grill backed by an acoustically transparent foam.

System data

Frequency response (-5 dB, Standard)43 - 170 Hz
 Frequency response (-5 dB, 100-Hz-Modus)43 - 125 Hz
 Max. sound pressure (1 m, Freifeld)¹
 with 10D 120 dB
 with D20/D80 122 dB
 with 5D/30D/40D 122 dB

Loudspeaker data

Nominal impedance 8 Ohm
 Power handling capacity (RMS/peak 10 msec)200/1000 W
 Components 2 x 6,5" Lautsprecher
 Connections2 x NLT4 F/M
 optional 2 x NL4 M
 Pin assignment 2+ / 2-
 Weight 1.8 kg

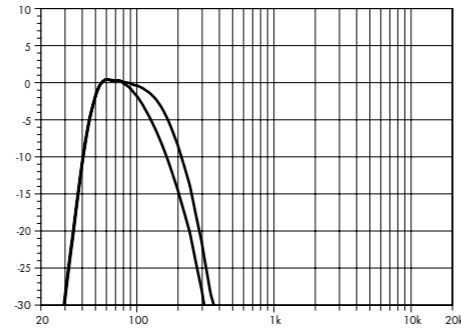

Frequency response B8 standard and 100 Hz mode

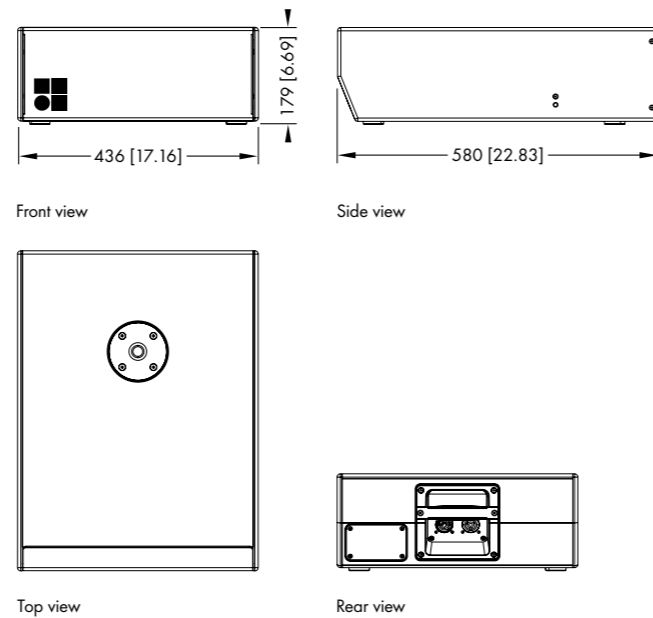

B8-SUB cabinet dimensions in mm [inch]

The B4 subwoofer

B4 subwoofer

The B4-SUB is an actively driven cardioid subwoofer powered by a single amplifier channel. It houses two long excursion neodymium drivers in an integrated cardioid setup: a 15" driver in a bass-reflex design facing to the front and a 12" driver in a two chamber bandpass design radiating to the rear. The cardioid dispersion pattern resulting from this arrangement unwanted energy behind the system that greatly reduces the excitation of the reverberant field at low frequencies and provides the greatest accuracy of low frequency reproduction. The B4 subwoofer can only be used in a ground stacked configuration. The B4-SUB cabinet is constructed from marine plywood and has an impact and weather resistant paint finish and a pair of handles. An M20 threaded flange in the top panel accepts the d&b Loudspeaker stand winder M20. The front of the loudspeaker cabinet is protected by a rigid metal grill backed by an acoustically transparent foam. Two runners extend from the rear to the front panel of the cabinet protecting the bottom panel against scratching. Two correspondingly shaped recesses are incorporated in the top panel of each cabinet that accept these runners to prevent cabinet movement when stacked.

System data

Frequency response (-5 dB standard)40 - 150 Hz
 Frequency response (-5 dB 100 Hz mode)40 - 100 Hz
 Max. sound pressure (1 m, free field)¹
 with 10D 128 dB
 with D20/30D/40D 131 dB
 with D40/D80 131 dB

Loudspeaker data

Nominal impedance6 ohms
 Power handling capacity (RMS/peak 10 msec)500/2000 W
 Components
 Front/Rear 15"/12" driver
 Connections2 x NLT4 F/M
 optional 2 x NL4
 Weight 44 kg (97 lb)

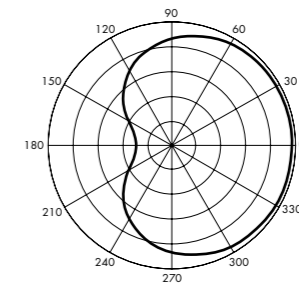

Cardioid polar pattern

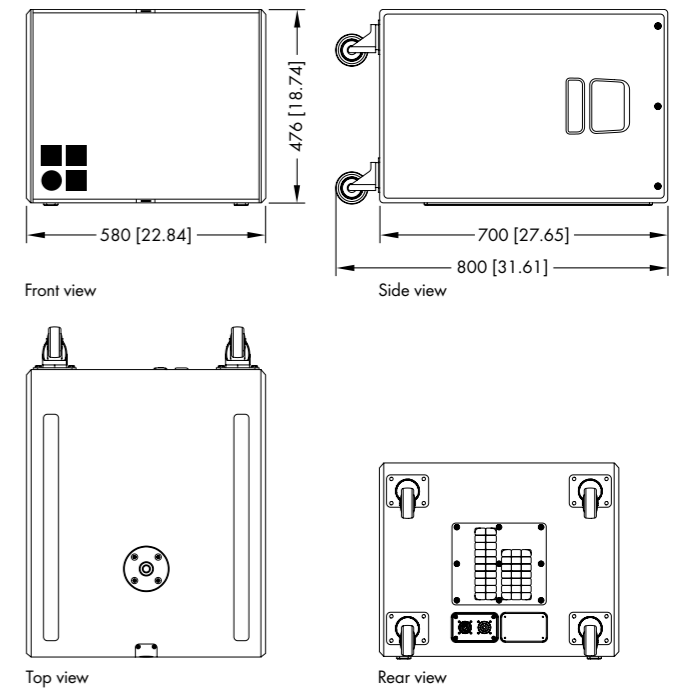

B4-SUB cabinet dimensions in mm [inch]

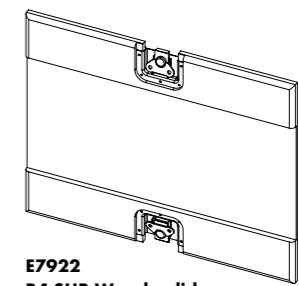

E7922 B4-SUB Wooden lid

The E4/E5 mounting accessories

The B8 mounting accessories

Safety approval

d&b loudspeakers and accessories are designed for setup and use within situations requiring compliance with the provisions and directives of the DGUV regulation 17 (formerly BGV C1).



Z5357
Ball joint adapter

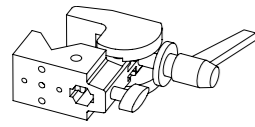

E6532
Super clamp
For tube diameters from
13 to 55 mm/0.5" to 2.17"



E6533
Adapter M10
for super clamp

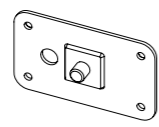

Z5038
Fixing plate M10

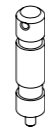

Z5029
TV Spigot M10

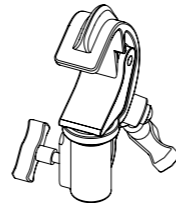

Z5012
Pipe clamp for TV Spigot
For a tube diameter up to
70 mm/2.75"

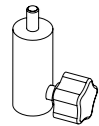

Z5034
Stand adapter M10



Z5035
Adapter M10 to 3/8"

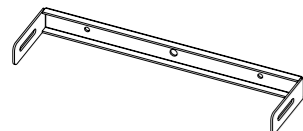

Z5450
B8 Horizontal bracket

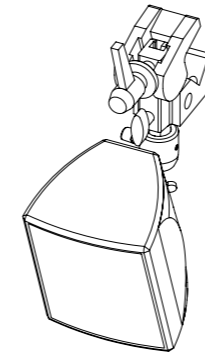

E4/E5 with
Z5357 Ball joint adapter
E6532 Super clamp
E6533 Adapter M10
for super clamp

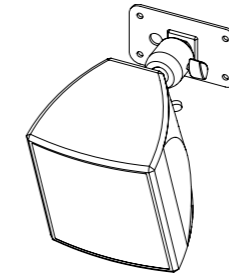

E4/E5 with
Z5357 Ball joint adapter
Z5038 Fixing plate M10

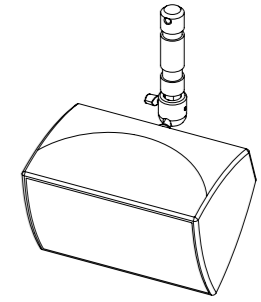

E4/E5 with
Z5357 Ball joint adapter
Z5029 TV Spigot M10

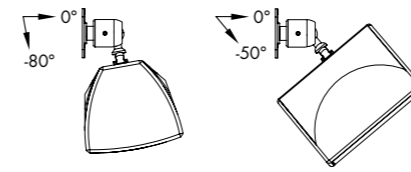

E4 angle settings

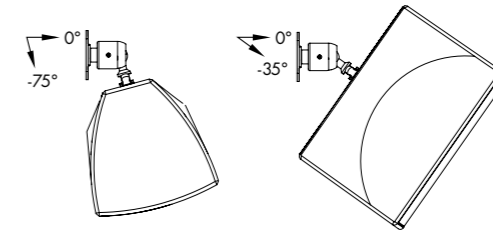

E5 angle settings

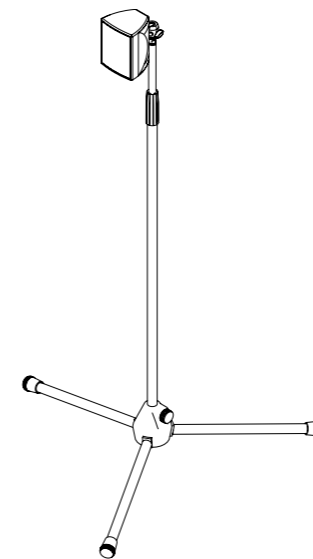

E4/E5 mounted on a microphone stand with
Z5357 Ball joint adapter
Z5035 Adapter M10 to 3/8"

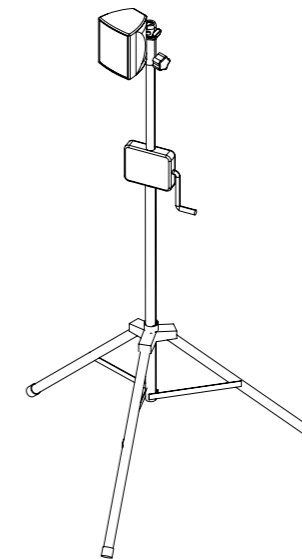

E4/E5 with
Z5357 Ball joint adapter
Z5034 Stand adapter M10
Z5009 Loudspeaker stand with winder

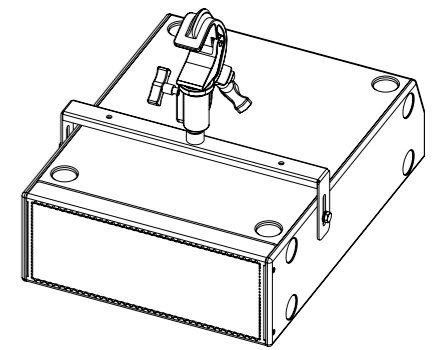

B8-SUB with
Z5450 B8 Horizontal bracket
Z5029 TV spigot M10
Z5012 Pipe clamp with TV spigot

The E6 mounting accessories

The E6 mounting examples

Safety approval

d&b loudspeakers and accessories are designed for setup and use within situations requiring compliance with the provisions and directives of the DGUV regulation 17 (formerly BGV C1).

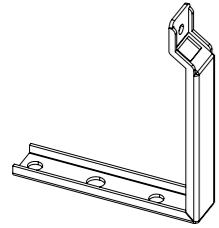

Z5377
E6 Swivel bracket

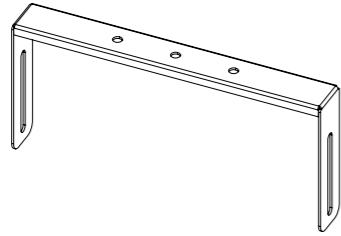

Z5378
E6 Horizontal bracket

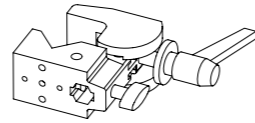

E6532
Super clamp
For tube diameters from
13 to 55 mm/0.5" to 2.17"



E6533
Adapter M10
for super clamp

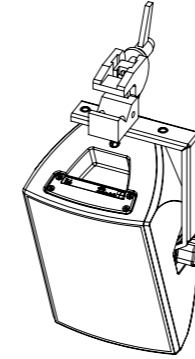

E6 with
Z5377 E6 Swivel bracket
E6532 Super clamp
E6533 Adapter M10
for super clamp

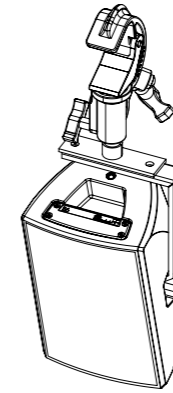

E6 with
Z5377 E6 Swivel bracket
Z5010 TV Spigot with fixing plate
Z5012 Pipe clamp

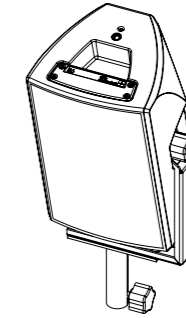

E6 with
Z5377 E6 Swivel bracket
Z5024 Loudspeaker stand adapter

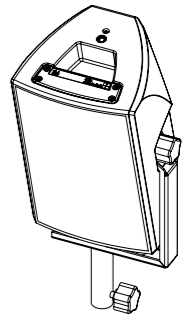

E6 with
Z5377 E6 Swivel bracket
Z5034 Stand adapter M10

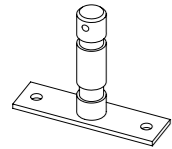

Z5010
TV Spigot
with fixing plate

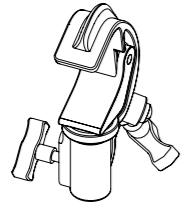

Z5012
Pipe clamp for TV Spigot
For a tube diameter up to
70 mm/2.75"

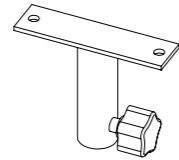

Z5024
Loudspeaker
stand adapter

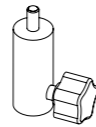

Z5034
Stand adapter M10



Q9031
Safety eyebolt M8

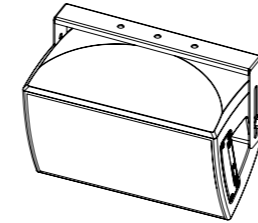

E6 with
Z5378 E6 Horizontal bracket

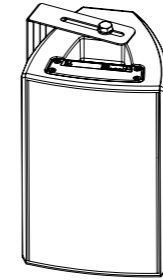

E6 with
Z5378 E6 Horizontal bracket

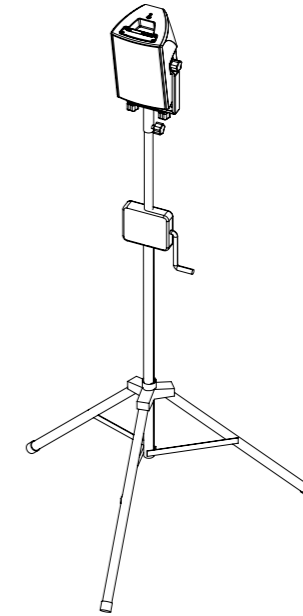

E6 with
Z5377 E6 Swivel bracket
Z5024 Loudspeaker stand adapter
Z5009 Loudspeaker stand
with winder

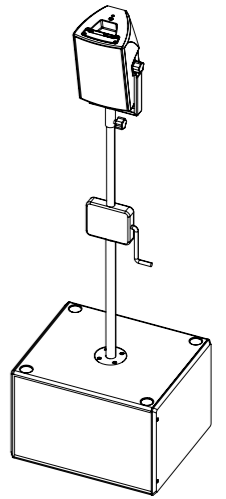

E6 with
Z5377 E6 Swivel bracket
Z5034 Stand adapter M10
Z5013 M20 pole with winder

The E8/E12 mounting accessories

The E8/E12 mounting examples

Safety approval

d&b loudspeakers and accessories are designed for setup and use within situations requiring compliance with the provisions and directives of the DGUV regulation 17 (formerly BGV C1).

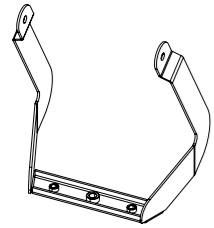

Z5350
E8 Flying bracket
Z5352
E12 Flying bracket

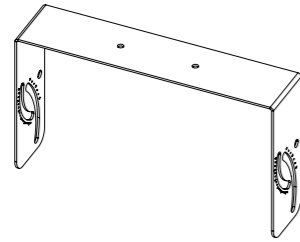

Z5351
E8 Horizontal bracket
Z5353
E12 Horizontal bracket

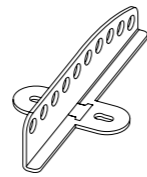

Z5354
E8/E12 Flying adapter



Z5355
E8/E12 Flying adapter link

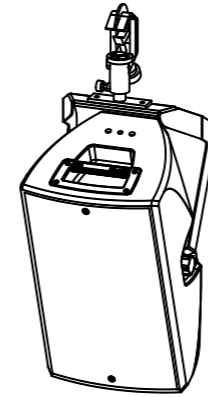

E8/E12 with
Z5350 E8 Flying bracket or
Z5352 E12 Flying bracket
Z5010 TV Spigot with fixing plate
Z5012 Pipe clamp

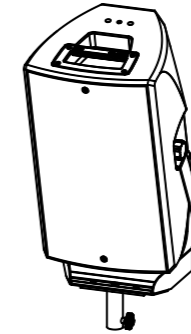

E8/E12 with
Z5350 E8 Flying bracket or
Z5352 E12 Flying bracket
Z5024 Loudspeaker stand adapter

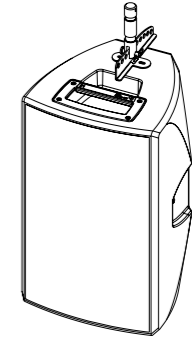

E8/E12 with
Z5354 E8/E12 Flying adapter
Z5015 TV Spigot 02

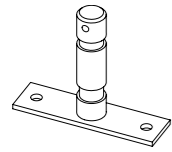

Z5010
TV Spigot
with fixing plate

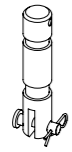

Z5015
TV Spigot 02

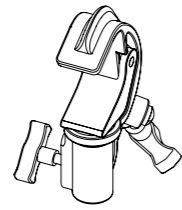

Z5012
Pipe clamp for TV Spigot
For a tube diameter up to
70 mm/2.75"

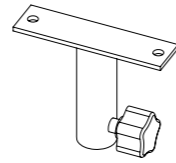

Z5024
Loudspeaker
stand adapter

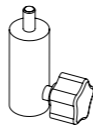

Z5034
Stand adapter M10

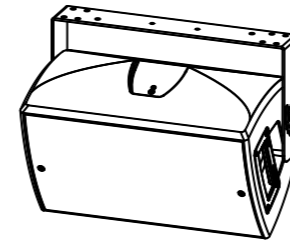

E8/E12 with
Z5351 E8 Horizontal bracket or
Z5353 E12 Horizontal bracket

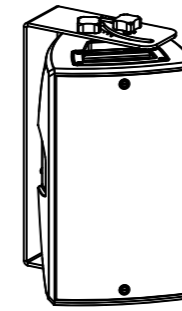

E8/E12 with
Z5351 E8 Horizontal bracket or
Z5353 E12 Horizontal bracket

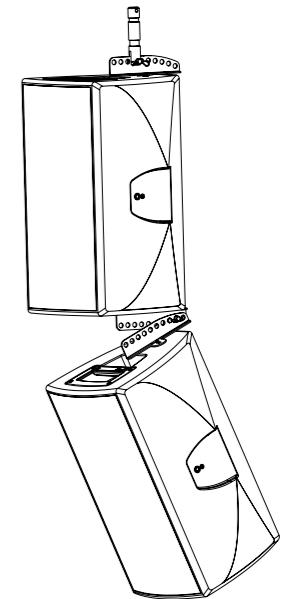

E8 or E12 vertically arrayed for
far and near field coverage with
Z5354 E8/E12 Flying adapter
Z5355 E8/E12 Flying adapter link
Z5015 TV Spigot 02



Q9032
Safety eyebolt M10

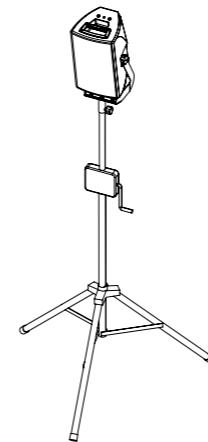

E8/E12 with
Z5350 E8 or Z5352 E12 Flying bracket
Z5034 Stand adapter M10
Z5009 Loudspeaker stand with winder

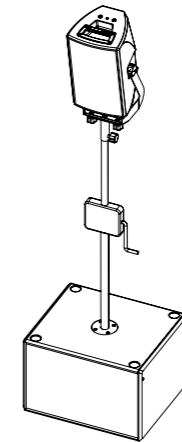

E8/E12 with
Z5350 E8 or Z5352 E12 Flying bracket
Z5024 Loudspeaker stand adapter
Z5013 M20 pole with winder

The E-Series Weather Resistant, Special Colour and Custom solutions options

Weather Resistant (WR) option

The WR option provides an IP54 rating, and enables operation of loudspeakers in changing ambient conditions, with some loudspeakers able to achieve an IP55 rating. However it is not intended to enable permanent, unprotected operation of loudspeakers outdoors. Cabinets used outdoors even with the WR option should always be aimed either horizontally or with a downward tilt. All WR speakers will be delivered without a cable. An optional WR cable (Z5763.000 - H07-RN-F 2 x 2.5 mm² / AWG 13, Faston connector type 2 x 6.3 mm male) with a standard length of 5.5 m is available. Other length on request.

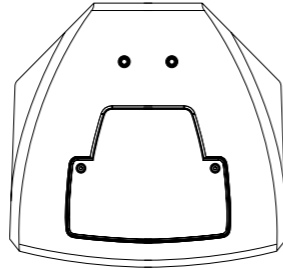

E6 WR/SC option top view and E8, E12 and WR/SC options top and bottom view

Special Colour (SC) option

The paint finish of all loudspeaker cabinets and most accessories can be executed in almost any custom colour in accordance with common colour tables. All rigging fittings at the rear of the cabinet, Front links and Locking pins remain in black. Other paint finishes such as metallic are available on request. The acoustically transparent foam fitted behind the rigid metal grill is also painted with the requested special colour.

Custom solutions (SWR) option

SWR (Sea Water Resistant) loudspeaker models are based on WR or SVS variants where available, and withstand outdoor operation in wet and acid or salty environments like on cruise ships or coastal locations. Other custom solutions are available upon request.

The E4 and E5 cases

The E7460 Touring case is also supplied with four extra 'E4 foam insert sets' each comprising two bottom inserts and one upright divider. These insert sets enable each of the E5 compartments to be transformed to accommodate two E4 loudspeakers. A set can either be permanently fixed in place or used as and when required. The photographs below show two examples of how the case can be converted.



E7458
Touring case 4 x E4

E7458 Touring case for
4 x E4 loudspeaker
4 x Z5357 Ball joint adapter
4 x E6532 Super clamp

E7460
Touring case 4 x E5

E7460 Touring case for
4 x E5 loudspeaker
4 x Z5357 Ball joint adapter
4 x E6532 Super clamp



E7460 Touring case with
4 x E5 loudspeaker
4 x Z5357 Ball joint adapter
4 x E6532 Super clamp

E7460 Touring case with
4 x E4 loudspeaker
2 x E5 loudspeaker
6 x Z5357 Ball joint adapter
4 x E6532 Super clamp

E7460 Touring case with
8 x E4 loudspeaker
8 x Z5357 Ball joint adapter
4 x E6532 Super clamp

The d&b ArrayCalc simulation software

The d&b NoizCalc immission modelling software

The d&b ArrayCalc simulation software is the simulation tool for d&b line arrays, column and point source loudspeakers as well as subwoofers. This is a comprehensive toolbox for all tasks associated with acoustic design, performance prediction, alignment, rigging and safety parameters. d&b ArrayCalc is available as a native stand-alone application for both Microsoft Windows¹ (Win7 64-bit or later) and Mac OS X² (10.12 or later) operating systems. In combination with the d&b Remote network, this can significantly reduce setup and tuning time in mobile applications, and allows for precise initial simulations when planning installations. Listening planes can be defined in the venue tab, creating a three dimensional representation of any audience area in a given venue. All sources can be time aligned, and the phase response of a flown system and a ground stacked SUB array can be aligned at a definable reference point. The comprehensive simulation precisely models the actual performance of the system, taking into account input level, all system configuration options (such as CUT, CPL, HFC or INFRA), limiter headroom and air absorption. Acoustic obstacles, such as video screens, can be added to a model. Acoustic shadowing, whether by these obstacles, or a balcony overhang, is taken into consideration. The level distribution resulting from the interaction of all active sources can be mapped onto the audience areas in a three-dimensional view. The Remote ID for all devices can be managed in the amplifier tab. EASE and DXF data export capabilities are also available.

A reference point can be defined for the d&b NoizCalc immission modelling software, which can be used to model the far field noise immission from a d&b sound reinforcement system. NoizCalc uses loudspeaker data from the ArrayCalc simulation file and displays the immission on a terrain map, presenting the calculated Sound Pressure Levels in dB(A) applying the selected frequency spectrum using either the ISO 9613-2 or Nord2000 standards.

The R1 Remote control software uses the data defined in ArrayCalc to generate an intuitive graphical user interface including the complete setup of the simulated system and all configuration information. This workflow removes the need to manually transfer data from one software program to the other. Further information is provided in the d&b Amplifier and Software brochure which is available for download at www.dbaudio.com.

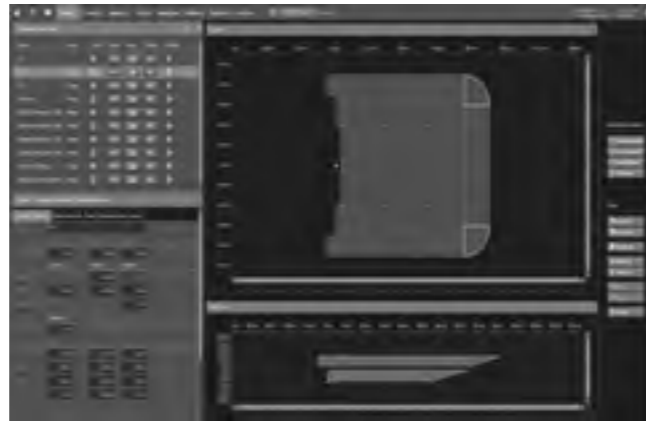

Venue

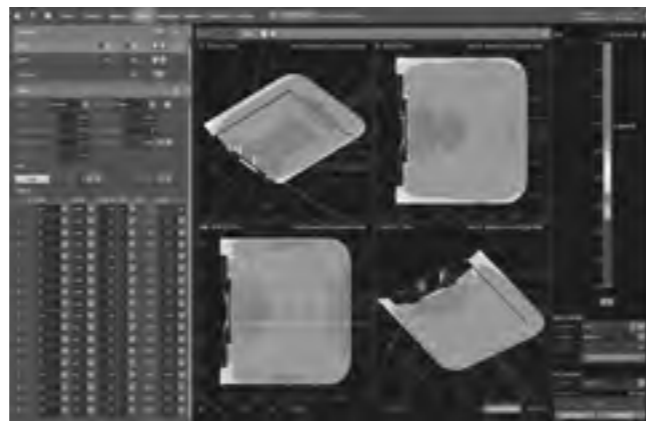

3D Plot quad



NoizCalc results map

The d&b Remote network

The remote control capability of the d&b Remote Network enables central control and monitoring of a complete d&b loudspeaker system from anywhere in the network, be it from a computer in the control room, at the mix position, or on a wireless tablet in the auditorium. This central access to all functions throughout the d&b Remote Network unlocks the full potential of the d&b system approach. In a typical user workflow, the d&b Remote Network takes settings optimized in the d&b ArrayCalc simulation software and applies these to all the amplifiers within the network.

All functions and controls available on the front panel of d&b amplifiers may be remotely controlled and/or monitored using the d&b R1 Remote control software. This allows each channel of the amplifier to be controlled and enables the creation of groups of loudspeakers. When grouped together, a button or fader can control the overall system level, zone level, equalization and delay, power ON/OFF, MUTE, as well as loudspeaker specific function switches such as CUT/HFA/HFC and CPL. An offline mode is provided for preparation in advance of an event, without the amplifiers being present or connected.

d&b System check verifies that the system performs within a predefined condition, while the Array verification function automatically identifies the physical position of a loudspeaker in an array to check that the system is cabled correctly. Extensive facilities for storing and recalling system settings are provided allowing these to be repeated, as and when required. For mobile applications, project files can be easily adjusted for use with a different set of equipment at another location.

The R1 software is optimized for use with touch screen, mouse and keyboard and runs on both Microsoft Windows¹ (Win7 64-bit or later) and Mac OS X² (10.12 or later).

In installation projects the R90 Touchscreen remote control can be used for quick and reliable operation of day-to-day functions of a pre-configured d&b system without needing expert level knowledge of audio. The built-in 7" panel PC provides users with one-touch control over power, mute, level, grouping and recall of up to nine AmpPresets, entirely independent of R1.

Further information is provided at www.dbaudio.com.



Home



Remote in Configuration mode

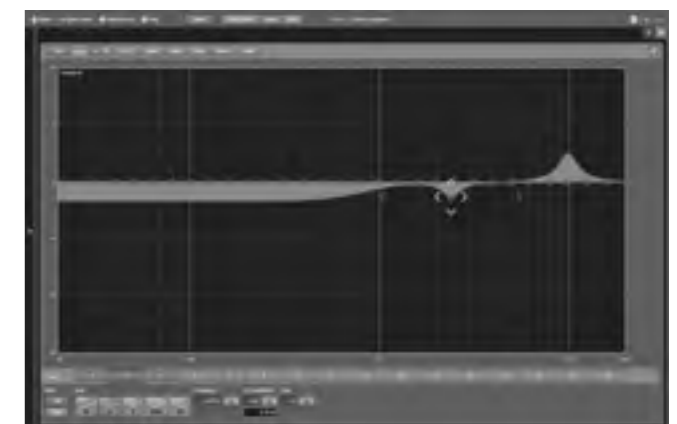

16-band equalizer

¹ Microsoft Windows is a registered trademark or trademark of Microsoft Corporation in the United States and/or other countries

² Mac OS X is a trademark of Apple Inc., registered in the U.S. and other countries

The d&b amplifiers



The d&b amplifiers are designed specifically to power d&b loudspeakers and are the beating heart of the d&b System reality. As such, they incorporate Digital Signal Processing for comprehensive loudspeaker management, switchable filter functions, remote capabilities and user-definable controls, to fulfil the exact needs of each application. Every loudspeaker configuration combines comprehensive system limiting, and equalization and crossover settings to ensure consistent results and optimal performance. d&b amplifiers offer

different output configurations for different loudspeaker setups, including Dual Channel mode, for passive setups, Mix TOP/SUB mode, in which two channels are driven through a single output connector, and 2-Way Active mode, which also sends the output of two channels down one connector to drive appropriate loudspeakers actively. The d&b switch functions provide selected filters to precisely tailor a wide variety of setups to their applications. Examples of these switch functions are the CSA (Cardioid Subwoofer Array)

and HFC (High Frequency Compensation) modes. CSA increases low frequency directivity control by minimising energy transmission towards the rear while HFC compensates for air absorption for loudspeakers covering far field listening positions. In addition to these functions, d&b amplifiers offer a comprehensive set of specific filters such as CUT, a cut mode for TOP loudspeakers when used with d&b subwoofers; CPL, to compensate for the coupling effect between loudspeakers in close proximity to other loudspeakers or hard objects and HFA

mode, to attenuate the high frequencies of a loudspeaker to mimic the effect of far field listening. These devices offer extended, user-definable equalization and delay capabilities, eliminating the need for external processing devices in the signal chain. All d&b amplifiers integrate with the d&b Remote network to enable the remote control and management of systems from anywhere within a network. Further information is provided in the d&b Amplifier and Software brochure which is available for download at www.dbaudio.com.

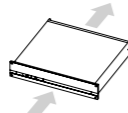
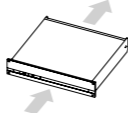
Comparison of the d&b amplifiers

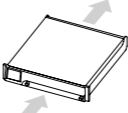
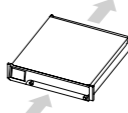
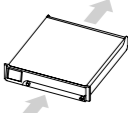
	5D	10D	30D	40D	D20	D40	D80
User interface	LED indicators	LED indicators	LED indicators	Colour TFT touchscreen	Encoder/colour TFT touchscreen	Encoder/colour TFT touchscreen	Encoder/colour TFT touchscreen
Output channels	4	4	4	4	4	4	4
Input channels	4 x Dante and 4 x analog	4 x AES3 and 4 x analog	4 x AES3 and 4 x analog	4 x AES3 and 4 x analog	4 x AES3 or 4 x analog or 2 x AES3 and 2 x analog	4 x AES3 or 4 x analog	4 x AES3 or 4 x analog or 2 x AES3 and 2 x analog
Latency	1.1 msec (analog) / < 4 msec (Dante)	0.3 msec	0.3 msec	0.3 msec	0.3 msec	0.3 msec	0.3 msec
User equalizers (per channel)	8-band	2 x 16-band	2 x 16-band	2 x 16-band	2 x 16-band	2 x 16-band	2 x 16-band
Delay	1.1 - 300 msec	10 sec/3440 m	10 sec/3440 m	10 sec/3440 m	10 sec/3440 m	10 sec/3440 m	10 sec/3440 m
Maximum output power (THD+N < 0.5%, 12 dB crest factor)	4 x 600 W into 4/8 ohms	4 x 350 W into 8 ohms 4 x 700 W into 4 ohms	4 x 800 W into 8 ohms 4 x 1600 W into 4 ohms	4 x 2000 W into 8 ohms 4 x 2400 W into 4 ohms	4 x 800 W into 8 ohms 4 x 1600 W into 4 ohms	4 x 2000 W into 8 ohms 4 x 2400 W into 4 ohms	4 x 2000 W into 8 ohms 4 x 4000 W into 4 ohms
Output routing		Dual Channel, Mix TOP/SUB 2-Way Active	Dual Channel, Mix TOP/SUB 2-Way Active	Dual Channel, Mix TOP/SUB 2-Way Active	Dual Channel, Mix TOP/SUB 2-Way Active	Dual Channel, Mix TOP/SUB 2-Way Active	Dual Channel, Mix TOP/SUB 2-Way Active
Output connectors	Phoenix Euroblock	Phoenix Euroblock	Phoenix Euroblock	Phoenix Euroblock	NL4 plus central NL8	NL4 plus central NL8	NL4 plus central NL8
GPIO connector	Phoenix Euroblock 4 ports (GPI)	Phoenix Euroblock 5 ports	Phoenix Euroblock 5 ports	Phoenix Euroblock 12 ports	No	No	No
Cable compensation	LoadMatch	LoadMatch	LoadMatch	LoadMatch	LoadMatch	LoadMatch	LoadMatch
Power supply	Universal range switched mode power supply with active PFC	Universal range switched mode power supply with active PFC	Universal range switched mode power supply with active PFC	Autosensing switched mode power supply with active PFC	Universal range switched mode power supply with active PFC	Autosensing switched mode power supply with active PFC	Autosensing switched mode power supply with active PFC
Mains voltage	100 - 240 V, 50 - 60 Hz	100 - 240 V, 50 - 60 Hz	100 - 240 V, 50 - 60 Hz	100 - 127/208 - 240 V, 50 - 60 Hz	100 - 240 V, 50 - 60 Hz	100 - 127/208 - 240 V, 50 - 60 Hz	100 - 127/208 - 240 V, 50 - 60 Hz
Weight (kg/lb)	4.6/10	10.6/23.4	10.6/23.4	13.3/29.3	10.8/23.8	13.8/30.4	19/42
Dimensions	1 RU x 9.5" x 405 mm	2 RU x 19" x 435 mm	2 RU x 19" x 435 mm	2 RU x 19" x 465 mm	2 RU x 19" x 460 mm	2 RU x 19" x 465 mm	2 RU x 19" x 530 mm
Remote	OCA/AES70 via Ethernet	OCA via Ethernet/CAN	OCA via Ethernet/CAN	OCA/AES70 via Ethernet	OCA via Ethernet/CAN	OCA/AES70 via Ethernet	OCA via Ethernet/CAN
Airflow							

The controller setups and operation with d&b amplifiers

CUT mode

Set to CUT, the cabinet low frequency level is reduced and is configured for use with d&b active subwoofers.

HFA mode

In HFA mode (High Frequency Attenuation), the HF response is rolled off. The HFA provides a natural, balanced frequency response when a unit is placed close to listeners in near field or delay use. HFA begins gradually at 1 kHz, dropping by approximately 3 dB at 10 kHz. This roll off mimics the decline in frequency response experienced when listening to a system from a distance in a typically reverberant room or auditorium.

CPL function

The CPL (Coupling) function compensates for coupling effects between closely coupled cabinets by reducing the low and mid frequency level. CPL begins gradually at 1 kHz, with maximum attenuation below 250 Hz (200 Hz for E4 and E5), providing a balanced frequency response when cabinets are used in arrays of two or more. The CPL function can be set in dB attenuation values between -9 and 0, or a positive CPL value which creates an adjustable low frequency boost (0 to +5 dB).

100 Hz mode

The 100Hz mode limits the upper operating frequency of the subwoofer to 100Hz, complementing top cabinets in full range mode.

140 Hz mode

For acoustic adjustment the 140 Hz mode can be selected. When the 140 Hz mode is selected, the upper operating frequency of the system is raised to 140 Hz. This may be selected to supplement E-Series loudspeakers operating in CUT mode, when the coupling of the systems requires more energy in this frequency band.

Passive operation of E12X-SUB in parallel to E8

The E8-X configuration in the d&b amplifiers should be selected when an E8 loudspeaker is used in combination with E12X subwoofers in passive mode driven from one amplifier channel. Compared to the standard E8 configuration, the E8-X configuration provides a dedicated correction for the combined frequency response of the loudspeaker and subwoofer. Selecting the E8-X configuration enables a combination of up to three E8 and E12X-SUBs to be driven by the respective channel.

Passive operation of E15X-SUB in parallel to E12/E12-D

The E12-X or E12-DX configurations in the d&b amplifiers should be selected when E12 or E12-D loudspeakers are used in combination with E15X-SUB loudspeakers in passive mode driven from one amplifier channel. Compared to the standard E12 and E12-D configurations, the E12-X and E12-DX configurations provide a dedicated correction for the combined frequency response of the loudspeaker and subwoofer. Selecting the E12-X or E12-DX configurations enables a combination of one E12/E12-D and one E15X-SUB loudspeakers to be driven by the respective channel.

Recommended amplifiers for mobile applications

	E4	E5	E6	E8	E12/E12-D	E12X-SUB	E15X-SUB	B4-SUB	B8
D20	x	x	x	x	x	x	x	x	x
D40	x	x	x	x	x	x	x	x	x

Recommended amplifiers for installation applications

	E4	E5	E6	E8	E12/E12-D	E12X-SUB	E15X-SUB	B4-SUB	B8
5D	x	x							x
10D	x	x							x
30D			x	x	x	x	x	x	x
40D			x	x	x	x	x	x	x

Maximum loudspeakers per amplifier channel

	E4	E5	E6	E8	E12/E12-D	E12X-SUB	E15X-SUB	B4-SUB	B8
	4	4	4	4	2	2	2	2	2

Available controller settings

	E4	E5	E6	E8	E12/E12-D	E12X-SUB	E15X-SUB	B4-SUB	B8
CUT	x	x	x	x	x				
HFA	x	x	x	x	x				
CPL	x	x	x	x	x				
100 Hz							x	x	x
140 Hz						x			

The E-Series frequency responses

The d&b amplifier output modes

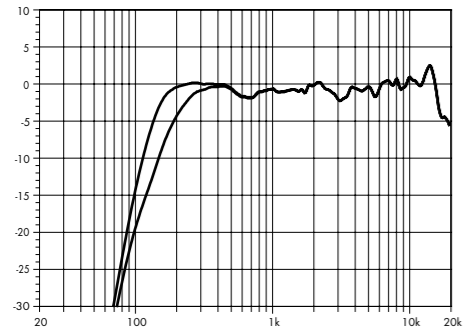

E4 standard and CUT

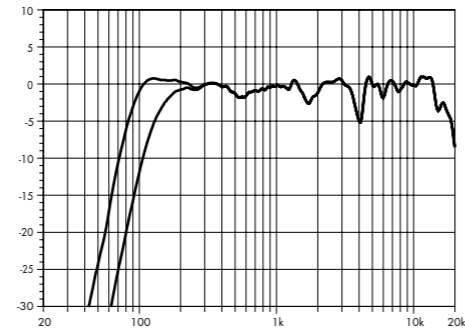

E5 standard and CUT

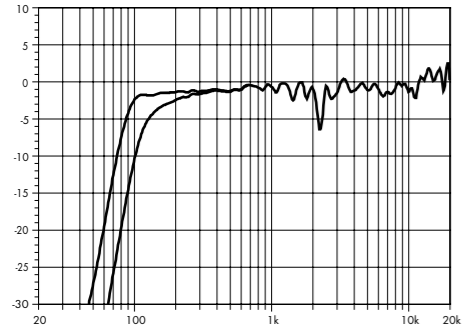

E6 standard and CUT

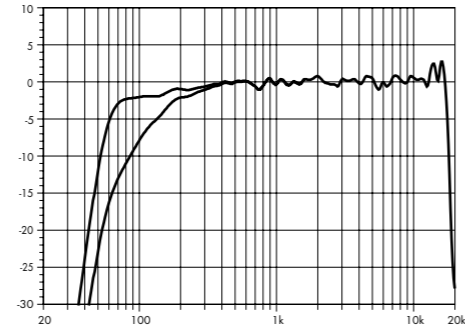

E8 standard and CUT

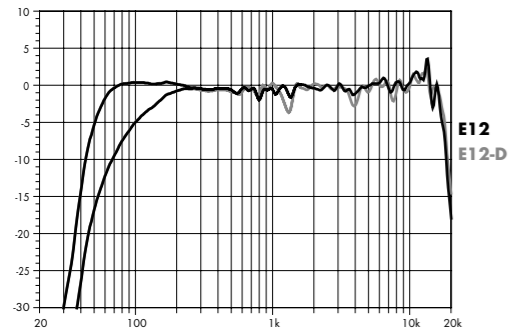

E12/E12-D standard and CUT

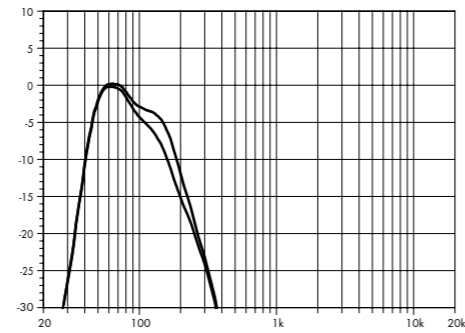

E12X-SUB standard and 140 Hz

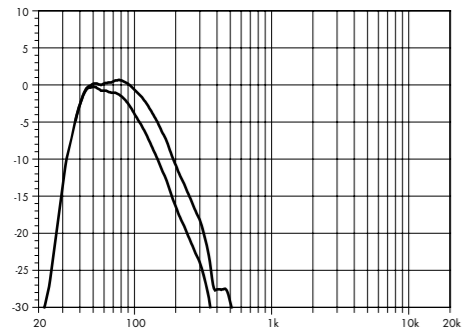

E15X-SUB standard and 100 Hz

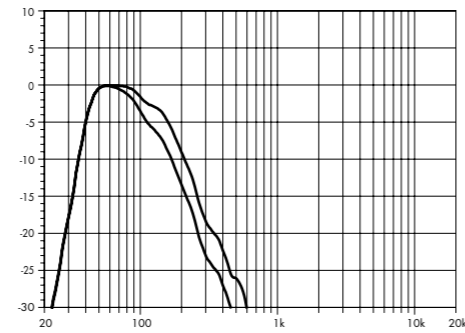

B4-SUB standard and 100 Hz

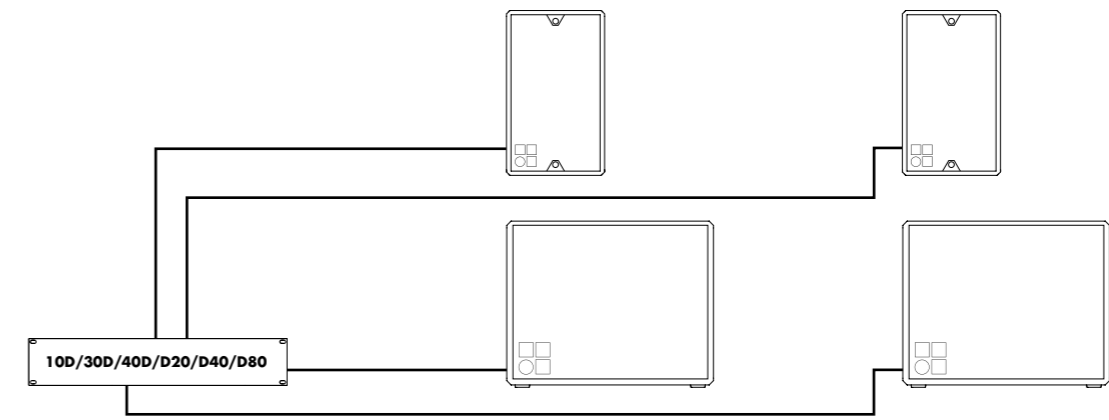

10D/30D/40D/D20/D40/D80 amplifier in Dual Channel mode for E4, E5, E6, E8, E12 or E12-D and B8-SUB, E12X-SUB, E15X-SUB or B4-SUB

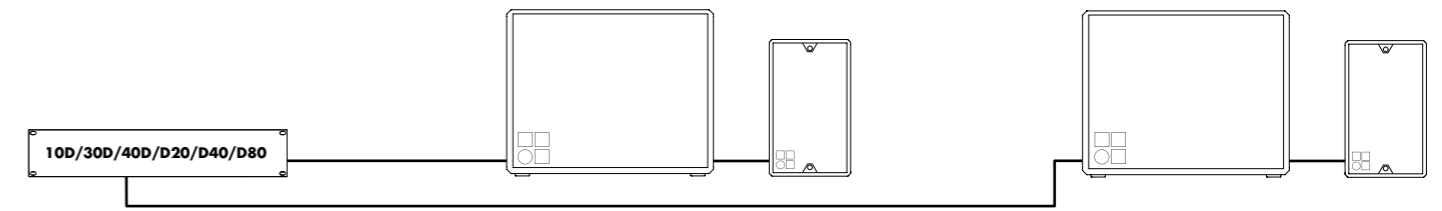

10D/30D/40D/D20/D40/D80 amplifier in Mix TOP/SUB mode for E4, E5, E6, E8, E12, E12-D, B8-SUB, E12X-SUB, E15X-SUB and B4-SUB

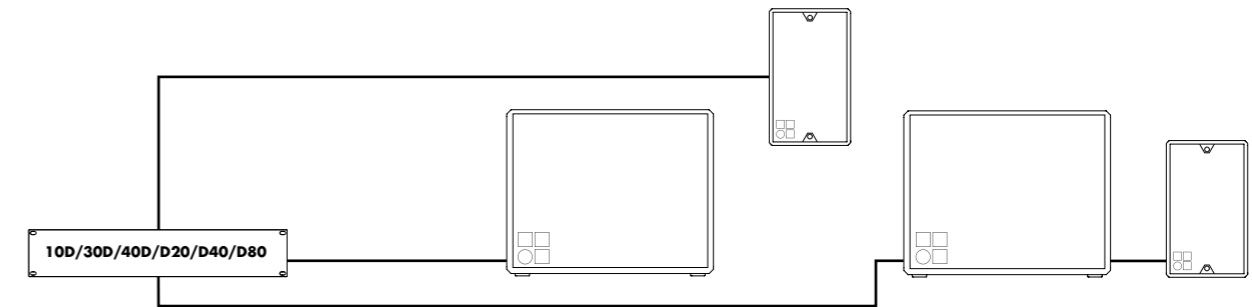

10D/30D/40D/D20/D40/D80 in a mixed configuration of Dual Channel and Mix TOP/SUB modes for E4, E5, E6, E8, E12, E12-D, B8-SUB, E12X-SUB, E15X-SUB and B4-SUB

The DS10 and DS20 Audio network bridges

The DS100 Signal Engine

DS10 Audio network bridge

The DS10 Audio network bridge interfaces between Dante networks and AES3 digital audio signals, while also providing distribution of Ethernet control data. Positioned within the signal chain in front of the amplifiers, this 1 RU device expands the d&b system approach. Each unit can deliver up to sixteen Dante network channels via AES3 digital signal outputs. Additionally, four AES3 input channels provide access to the Dante audio network for applications such as a break-in from a Front of House console. The DS10 incorporates an integrated 5-port switch, offering a primary and redundant network for the Dante protocol, as well as advanced functions such as Multicast Filtering and VLAN modes. Using the DS10 Audio network bridge, audio signals and remote control data can be combined using a single Ethernet cable.



The DS10 Audio network bridge front view



The DS10 Audio network bridge rear view

DS20 Audio network bridge

The DS20 Audio network bridge supports the open standards-based Milan protocol rather than Dante. Milan (Media integrated local area networking) is a high level interoperability solution based on Audio Video Bridging (AVB) technology. The main advantages are deterministic behaviour (zero network congestion); improved reliability; optimum synchronization and hassle free network setup, as no special settings, such as QoS, need to be set within the switches to ensure delivery.



The DS20 Audio network bridge front view



The DS20 Audio network bridge rear view

DS100 Signal Engine

The d&b DS100 Signal Engine is the platform underneath the Soundscape, based on a specialized rack mount 3 RU audio processor with Audinate Dante networking. It provides a 64 x 64 audio matrix with level and delay adjustments at all cross points. Additional software modules provide dynamic source positioning and emulated acoustics functions. The DS100 is a versatile tool for use within complex audio systems to route and distribute multiple audio channels to numerous amplifiers driving loudspeaker positions and zones, show relay and break out rooms. The networking capabilities with a Dante enabled processor are significant, particularly for busy, multi-room complexes. The DS100 completely integrates with the overall d&b system approach, including loudspeakers, amplifiers, rigging, transport and networking accessories and the DS10 Audio network bridge. The complete system is designed and optimized in the d&b ArrayCalc simulation software, and controlled via the d&b R1 Remote control software.



The DS100 Signal Engine front view



The DS100 Signal Engine rear view

The E-Series configuration examples

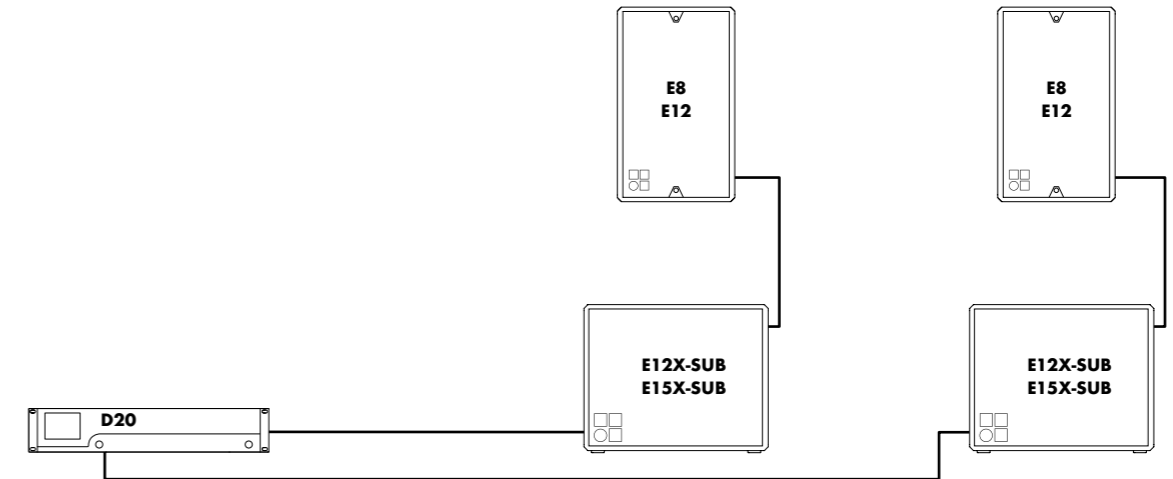

D20 amplifier in Mix TOP/SUB mode with E8 or E12 loudspeakers and E12X or E15X subwoofers



D20 amplifier in Mix TOP/SUB mode with E12 loudspeakers and B4 subwoofers as a powerful PA system and 5D amplifier in Dual Channel mode with E5 loudspeakers as nearfills

The E-Series cables and adapters

Amplifiers in Dual Channel mode

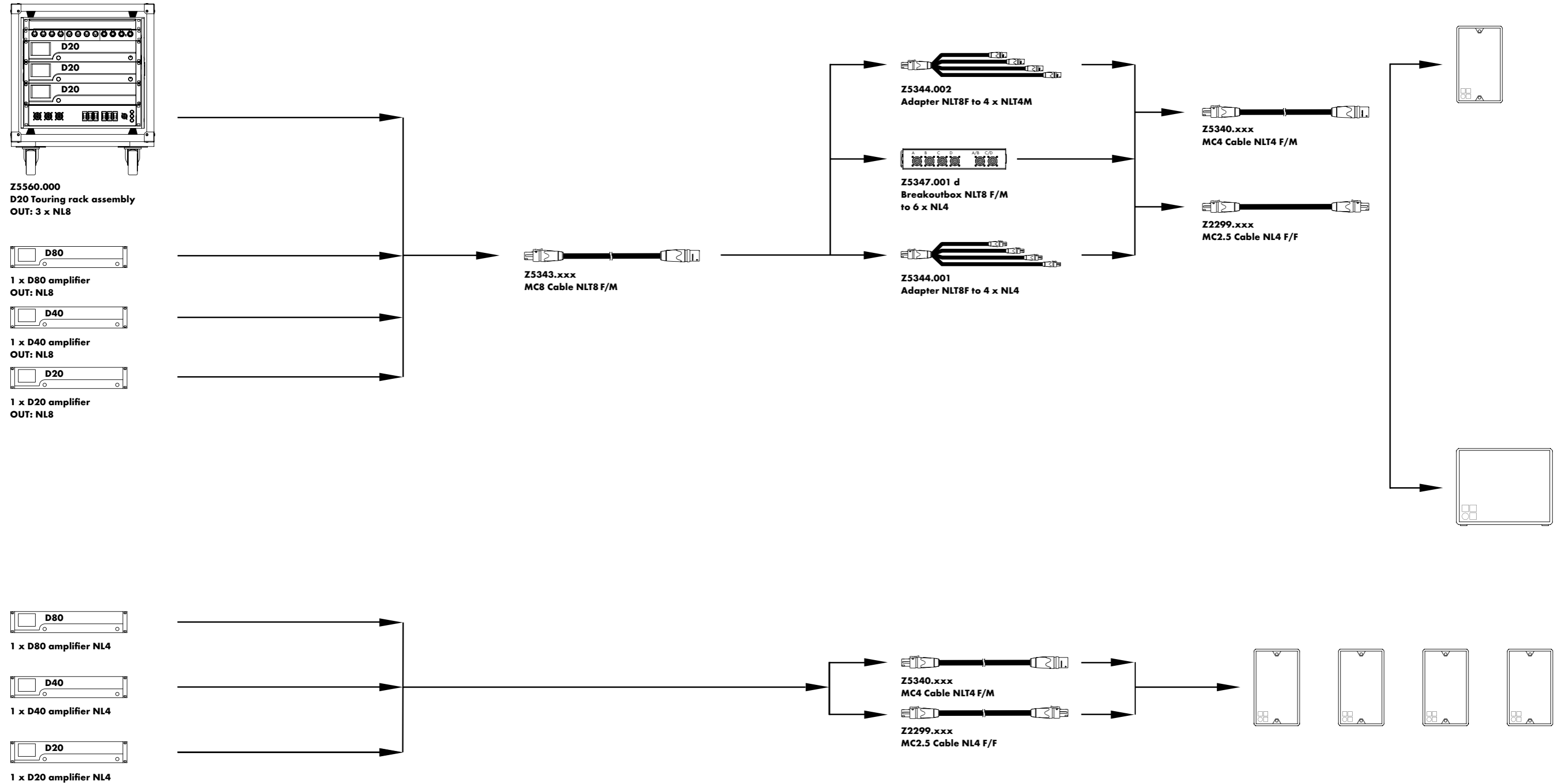

The E-Series product overview

Loudspeakers	Z0440.000	E4 loudspeaker NL4 connector	Z5012.500	Pipe clamp for TV Spigot	
	Z0450.000	E5 loudspeaker NL4 connector	Z5009.000	Loudspeaker stand with winder	
	Z0350.xxx	E6 loudspeaker	Z5013.000	M20 pole with winder	
	Z0620.xxx	E8 loudspeaker	Z5024.000	Loudspeaker stand adapter	
	Z0601.xxx	E12 loudspeaker	Q9031.000	Safety eyebolt M8	
	Z0602.xxx	E12-D loudspeaker	Q9032.000	Safety eyebolt M10	
	Z0210.xxx	E12X subwoofer			
	Z0615.xxx	E15X subwoofer			
	Z0610.xxx	B4 subwoofer			
	Z0630.xx1	B8 subwoofer			
	WR Weather Resistant¹				
	SC Special Colour²				
Loudspeaker connector options	Zxxxx.002	NLT4 F/M connector	Remote network	Z6118.000	R60 USB to CAN interface
	Zxxxx.001	NL4 connector		Z6124.000	R70 Ethernet to CAN interface
Loudspeaker cases	E7458.000	Touring case 4 x E4 integral tray, handle	Processing and distribution	Z4010.000	DS10 Audio network bridge
	E7460.000	Touring case 4 x E5 integral tray, handle		Z4011.000	DS20 Audio network bridge
	E7456.000	Touring case 2 x E6 hinged lid, integral tray, handles		Z4100.000	DS100 Signal Engine
	E7457.000	Touring case 4 x E6 hinged lid, integral tray, wheels			
	E7446.000	Touring case 2 x E8 hinged lid, integral tray, handles			
	E7447.000	Touring case 4 x E8 hinged lid, integral tray, wheels			
	E7445.000	Touring case 2 x E12 hinged lid, integral tray, wheels			
	E7448.000	Touring case 2 x E15X-SUB sleeve, wheels			
E7449.000	Touring case 2 x E12X-SUB sleeve, wheels				
Lid	E7922.000	B4-SUB Wooden lid	Amplifiers	Z2750.xxx	D20 amplifier³
Accessories	Z5357.000	Ball joint adapter²		Z2850.xxx	D40 amplifier³
	E6532.000	Super clamp		Z2710.xxx	D80 amplifier³
	E6533.000	Adapter M10 for Super clamp		Z2880.xxx	5D amplifier⁴
	Z5038.000	Fixing plate M10		Z2760.xxx	10D amplifier⁴
	Z5029.000	TV Spigot M10		Z2770.xxx	30D amplifier⁴
	Z5034.000	Stand adapter M10		Z2830.xxx	40D amplifier⁴
	Z5035.000	Adapter M10 to 3/8"			
	Z5377.000	E6 Swivel bracket²	Amplifier rack assemblies	Z5560.xxx	3 x D20 Touring rack⁵
	Z5378.000	E6 Horizontal bracket²		Z5561.xxx	3 x D20 Touring rack (includes DS10) ⁵
	Z5350.000	E8 Flying bracket²		Z5570.xxx	3 x D80 Touring rack⁵
	Z5351.000	E8 Horizontal bracket²		Z5571.xxx	3 x D80 Touring rack (includes DS10) ⁵
	Z5352.000	E12 Flying bracket²			
	Z5353.000	E12 Horizontal bracket²	Amplifier racks	E7480.000	D20 Touring rack 2 RU, 19" SD, shock mounted, handles
	Z5450.000	B8 Horizontal bracket		E7468.000	D80 Touring rack 2 RU, 19" SD, shock mounted, handles
	Z4550.901	B8 Horizontal bracket SC		E7483.000	DS100 Touring rack 3 RU, 19" SD, shock mounted, handles
	Z5354.000	E8/E12 Flying adapter²			
	Z5355.000	E8/E12 Flying adapter link			
	Z5010.000	TV Spigot with fixing plate	Cables	Z5339.000	Multichannel extension cable
	Z5015.000	TV Spigot for flying adapter 02		Z5343.xxx	MC8 Cable NLT8 F/M
				Z5345.001	Adapter 4 x NL4 to NLT8M
			Z5344.002	Adapter NLT8F to 4 x NLT4M	
			Z5344.001	Adapter NLT8F to 4 x NL4	
			Z5347.001	Breakoutbox NLT8 F/M to 6 x NL4	
			Z5340.xxx	MC4 Cable NLT4 F/M	
			Z2299.xxx	MC2.5 Cable NL4 F/F	
			Z5763.000	WR 5,5m cable 2x2.5mm^{2,6}	

³ The complete list of mobile amplifier versions is available in the d&b D Amplifier and Software brochure

⁴ The complete list of installation amplifier versions is available in the d&b xD Installation Amplifier and Software brochure

⁵ Further information is available in the d&b D Amplifier and Software brochure

⁶ Other lengths on request

